

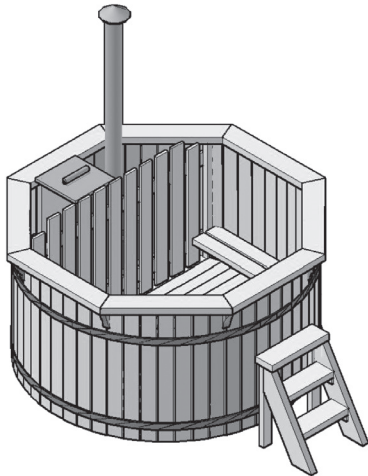

Hot tub

health, beauty, peace of mind

Specifications



Diameter, m	1,5	1,9	2,2
Capacity, l	1600	2550	3420
Weight, kg (empty hot tub)	250	350	450
Group of people	4-6	6-8	8-10

HOT TUB STANDARD SET

- Wooden hot tub
- Stainless steel built-in heater with a chimney
- Stainless steel hoops
- Safety fence
- Benches
- Outlet valve for water hose connection
- Stairs „3 steps“

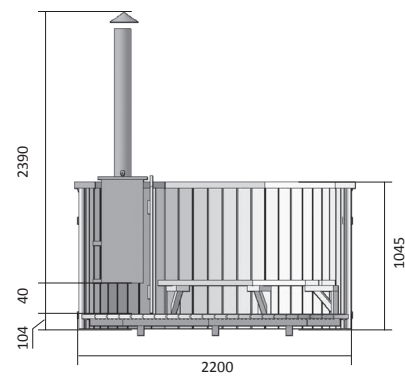
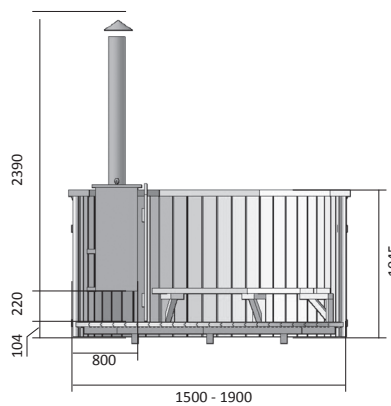
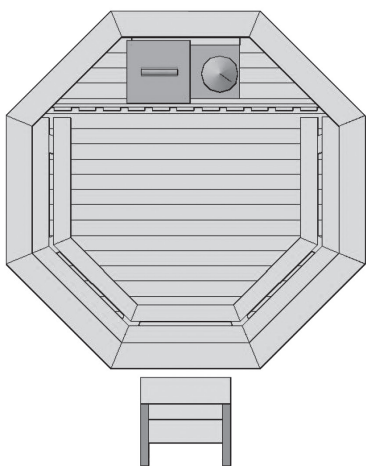
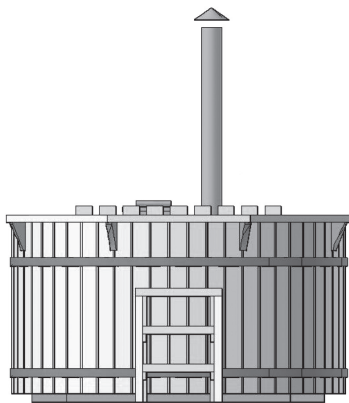

Water heaters

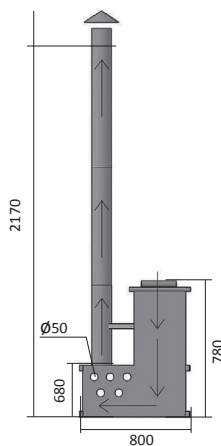

For \varnothing 1500/1900 diameter hot tub

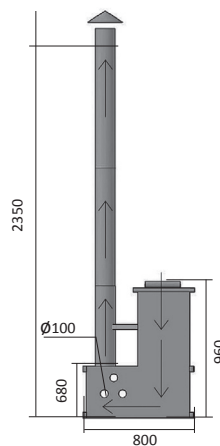

For \varnothing 2200 diameter hot tub

INSIDE WOOD BURNING HEATERS MADE OF STAINLESS STEEL.

Stainless steel metal 304 is the most widely used steel. Provides good resistance in moderately acidic solutions.

Types of wood



SPRUCE	The spruce is of Nordic species. It is light coloured, nearly white. Thin and regular texture. Suitable for painting and flexible. Spruce tubs are outstanding for being waterproof and durable.
LARCH	Larch is a wood valued for being tough, waterproof and durable; top quality knot-free wood is in great demand for building yachts and other small boats also for cladding and interior paneling. Resistant to decay.
THERMO WOOD	Thermo-wood of spruce is a product which is produced using a special high temperature (at least 180°C) kilning process which has been developed in Finland. The wood material is heated to certain temperature while it is protected with steam. Besides providing protection, the steam also affects the chemical changes taking place in the wood. As a result of the treatment, environmentally friendly Thermo-Wood is created. Its colour darkens, it is more stable than normal wood in conditions of changing humidity, and its thermal insulation properties are improved. If carried out at a sufficiently high temperature, treatment also makes the wood resistant to decay.

Accessories



TENT COVER

Tent cover for hot tub helps to keep water clean for a longer time.



WOODEN COVER

Wooden cover for hot tub helps to keep water clean for a longer time. 1,5m diameter covers consists of 2 parts, 1,9m diameter and 2,2m diameter covers consists of 3 parts.



STAIRS „2 STEPS“

Height – 65 cm; width – 50 cm.



BOTTLE HOLDER

Bottle holder for 5 bottles available in either larch or spruce.



MIXING PADDLE

Length of the shaft – 177 cm, width – 5 cm; Width of the blade– 14 cm; thickness – 2,5 cm



LED LIGHT

LED waterproof light with automatic color change. The lights are powered by 4 x AAA batteries (not included). Size: 11cm x 4,5cm. Price for 2 PCS.



SCOOP & POKER

A scoop and a poker with wooden handles for cleaning and maintenance of the hot tub heater. Height – 82 cm; Size of the shovel – 12x15 cm.



IMPREGNATION

Impregnation is produced from natural ingredients. It accentuates the texture of wood, protects wood from side effects of the atmosphere and UV rays.

Transportation



ASSEMBLED HOT TUBS



HOT TUBS IN THE BOXES

Box size: 200x120x60 cm



Usage



After purchasing our open air bath first of all you should fill it with water. At first water will leak, within 3-5 days the tub will swell and become completely tight. When preparing for bathing, the tub should be filled-in with water about 10 cm below the top, taking into account the number of people that are going to use it. Before heating the water, make sure that the heater is sub-

merged in water about 5-10 cm below the footing of the chimney. Firewood or briquettes can be used for heating; water is heated to 40°C in 2-4 hours depending on the material used for heating and air temperature.

Maintenance



At least once a year the functioning tub must be impregnated as it gives more durability. After usage the tub and water inside must be cleaned. If there is no need to change the water just remove impurities with a gripping device. If the hot tub is kept outside it should be drained before winter months come. It can be drained through a valve at the bottom of the tub for easy water disposal. Water also can be emptied by using a pump. For hot tub cleaning and maintenance the water pool maintenance equipment can be used. During the warm period of the year the tub must be kept full with water

to prevent wood becoming too dry which may cause it becoming non-waterproof; water must be removed only for cleaning reasons or when changing the water. In the cold period of the year the tub should be kept empty as the ice can cause damage. In winter there is sufficient humidity in the air which provides protection against desiccation. However, if the wood has slightly dried, the constriction rings must be tightened before pouring water. To avoid pollution, the tubs that are not used in the open air should be kept covered.