

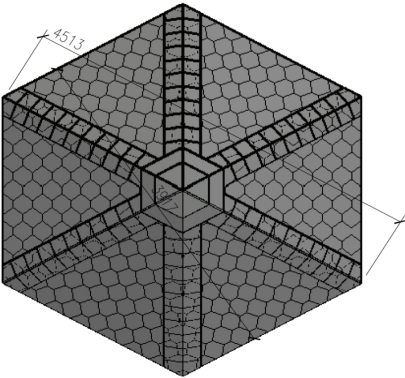

Pavilion

9,2 m²

health, beauty, peace of mind

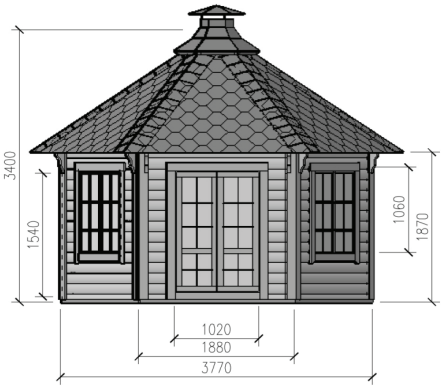
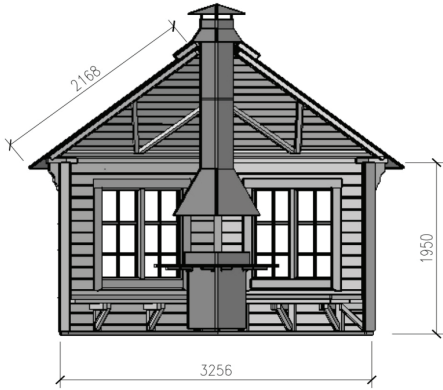
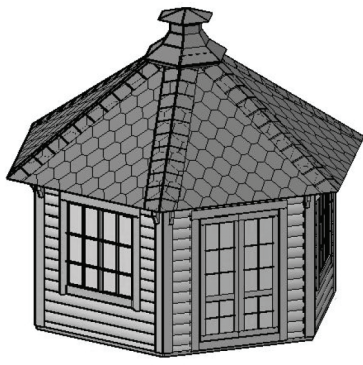

Specifications



Wood	Spruce
Shape	6 corners
Inside area, m ²	9.2
Total height, m	3.4
External dimensions (WxD), mm	3770x3256
Number of windows	5
Number of opening windows	2
Number of benches	5
Number of folding benches	2
Weight, kg	1400
Number of persons	12-15
Size of windows, mm	1020x1060
Size of doors, mm	1020x1540

STANDARD SET

- Wall, roof, floor panels;
- Inside grill with the cooking platforms and a table around the grill;
- Adjustable chimney;
- Double glass windows (2 of them can be opened);
- Double doors with a lock and windows;
- 5 inside benches (2 of them are folding benches);
- Cushions for the benches.

OPTIONS

- Roof shingles' color: red, black, green;
- 3 types of grill and chimney KITS;
- Cushions' color: blue or brown;
- Possibility to make more opening windows or closed walls;
- Pavilion without a grill is available;
- Additional products can be found on page 4.

Windows and doors



Window's size is 1020x1060 mm, door's size 1020x1540 mm. Double glass units are used; they ensure lower heat transfer to the outside, a lot of light coming inside, and long usage time.

Grill and chimney KITS



STANDARD GRILL AND CHIMNEY KIT

Standard set: Grill with the cooking platforms and a table around the grill; Adjustable chimney. Total height of the 6 corners grill chimney is 220 cm. Grill height till table is 70 cm. The grill is produced from 2 mm cold rolled steel sheets and welded using TIG type welding and the chimney is produced from 1 mm steel using spot-welding technique. All surfaces are painted using a powder coating. Powderpaints can withstand 200 degrees (not direct flames).

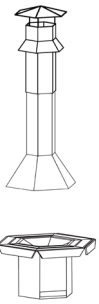

„VIKING“ GRILL AND CHIMNEY KIT

Standard set: Grill with the cooking platforms and a table around the grill; Adjustable chimney. Total height of the chimney is 206 cm. Grill height till table is 62 cm. All surfaces are painted using a powder coating. The powderpaint is marked to withstand 550 degrees (not direct flames).

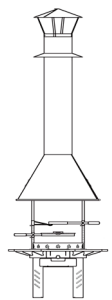

„LUXURY“ GRILL AND CHIMNEY KIT

Standard set: Grill with the cooking platforms and a table around the grill; Adjustable chimney. Total height of the chimney is 250 cm. Grill height till table is 75 cm. All surfaces are painted using a powder coating. The powderpaint is marked to withstand 400 degrees (not direct flames). „Luxury“ grill and chimney KIT does not need to be attached to the walls with the chains.

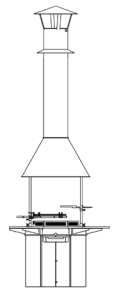

Roof shingles



BITUMEN SHINGLES

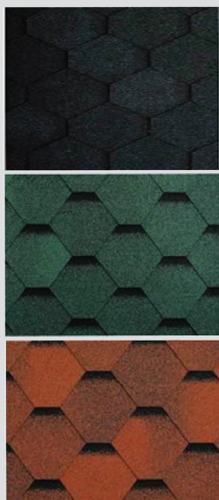

6 layer bitumen shingles are made from a durable and highly resistant fiber glass base coated with the polymer-reinforced bitumen mix which includes a high quality bitumen and an aggregate. The top layer of the shingles is covered with mineral granules ensuring the protection from UV as well as from other weather conditions. The granules are painted using a thermal method, which means that a pigment is burned-in into the surface of granules and this guarantees a long durability of the color. The bottom of the shingles is an adhesive polymer-reinforced bitumen layer protected with an easily removable silicon membrane. Due to the sun heat the overlapped tiles on the top stick to each other thus forming a double hydro-insulating layer which guarantees an excellent leak resistance of the roof. A color of the roof shingles can be chosen from black, green or red. A warranty term for the shingles is 15 years!

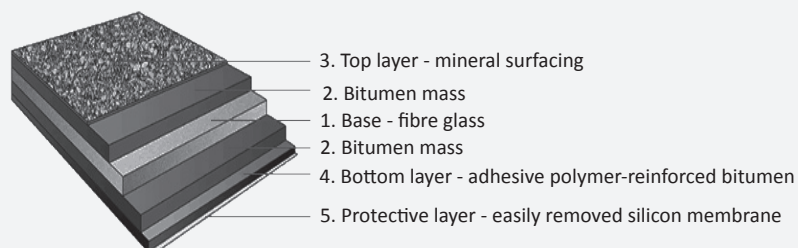

Type of wood



SPRUCE



We mainly use Nordic spruce, which comes from Scandinavia. The light, golden-white softwood radiates a friendly warmth. Every single board used for our Pavilion has its own individual character and history, and this makes our Pavilion a real natural and unique product.

Accessories



FLOWER POT

Flower pot should be placed under the windows. Size of the pot: 107 x 21 x 16 cm.



DRAWER

Drawer should be placed under the benches. Is suitable for all grill cabins and pavilions that have benches. Size of a drawer: 56 x 37 x 24 cm.



REINDEER HIDE

Natural reindeer hides. Country of origin - Finland. Size of the reindeer hides: 120 - 130 cm length.



SAFETY FENCE

Grill table's safety fence for a 6-corners grill. A solid steel fence provides better grill table protection from fire sparks.



GRILL COVER

Grill cover 6-corners. Grill cover is made from spruce. It covers the grill so that you can use the fireplace as a table.

Transportation

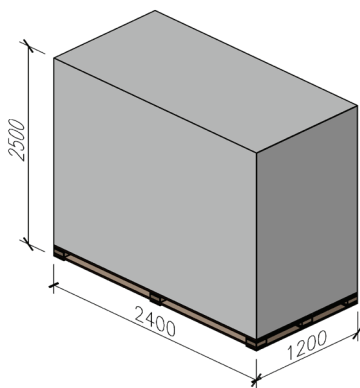

Pavilion KIT

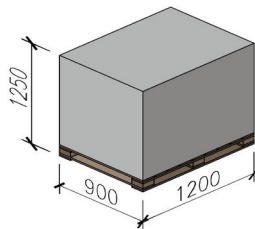

Standard 6-corners grill and chimney KIT

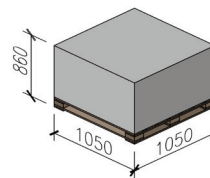

„Viking“ grill and chimney KIT

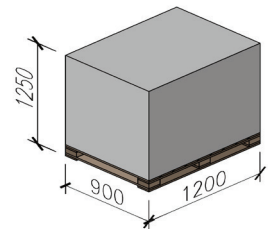

„Luxury“ grill and chimney KIT

Pavilion is delivered to the customer fully complete, with detailed assembly instructions and drawings, and packed on a pallet (KIT).

Standard grill is packed with the pavilion together but we strongly recommend to choose packing on a separate pallet.

„Viking“ and „Luxury“ grills are packed only on the separate pallets.

Pavilion KIT weight is **1400 kg**; Standard 6-corners grill and chimney KIT - **88 kg**; „Viking“ grill and chimney KIT - **96 kg**; „Luxury“ grill and chimney KIT - **96 kg**.

Foundation

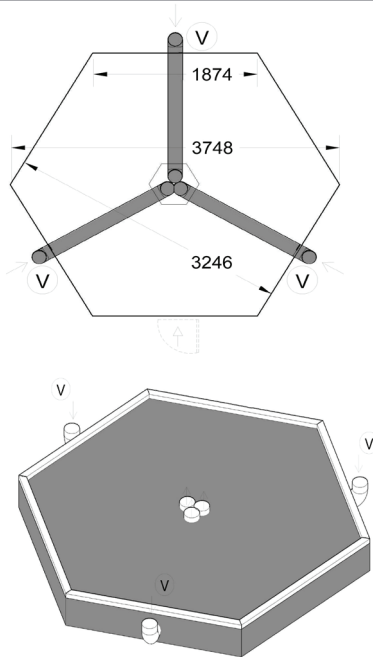

It is very important to have a proper foundation for your pavilion. Therefore we recommend making the foundation according to the sketches here.

First of all, foundation must be prepared according to the landscape and ground conditions. Consult a qualified builder or an engineer to prepare a proper foundation, which fits your location. Make sure to complete the site preparation and the foundation before unpacking and assembling the pavilion.

Also in order to avoid a smoke in the pavilion we strongly recommend installing 100-120 mm diameter ventilation pipes on 2 or 3 different foundation sides. Please note that these ventilation pipes must be covered so that no rain, leaves or anything else get there.

Usage



While using the grill for the first time a smoky smell may appear. We advise to keep the door open and not to cook until the smell has cleared. Some splitting and burning of the grill paint is normal.

Please note, that the grill has sharp edges and the steel parts of the grill heat up while using it, therefore there are risks to harm yourself or get burned. Make sure to be careful.

We suggest using the starter cubes or a little bit of a lighter fluid and small dry birch logs for starting the fire. To do it easier, ensure that the grill is getting enough air, so keep the door open. The bigger logs can be added to

the fire when it's already burning well. Choose a non-sparking wood; avoid using spruce or aspen and a wood covered with the bark. We advise to use logs with max length of 300 mm and DO NOT use the coal briquettes. A fresh air flow is the most important aspect to avoid the smoke, so make sure that there is enough of fresh air coming in. If the Pavilion is full of smoke, open the door of the Pavilion and make sure that the wood you use for the fire is dry and not covered with the bark. Provide additional dry wood if needed.

Remove the coals and ashes from the grill after they have cooled down.

Maintenance



As wood is a natural material, it can change through time. Cracks of various sizes, changes of the color as well as of a structure of the wood are not the errors, but a feature of wood.

Natural wood (not impregnated) becomes grayish after having been left untouched for a while. Later it can turn blue and get covered with the mold. Therefore, you should immediately impregnate the wood to protect the products.

We strongly recommend that you impregnate the door and windows with a wood impregnation agent both the inside and outside of them, because the doors and

windows can become twisted otherwise. In general, we recommend consulting a specialist regarding the paints suitable for an unprocessed softwood and follow the instructions of paints' manufacturers. Proper painting of the Pavilion will extend its lifetime. Besides that, we suggest you thoroughly inspecting the pod every six months and checking if it needs re-painting or else.

It's NOT advisable to paint the Pavilion walls before assembling it – this is best done when the Pavilion has been already assembled and when the weather is fine. However, if you wish to paint some parts in different colors, this should be done before the Pavilion is assembled.