

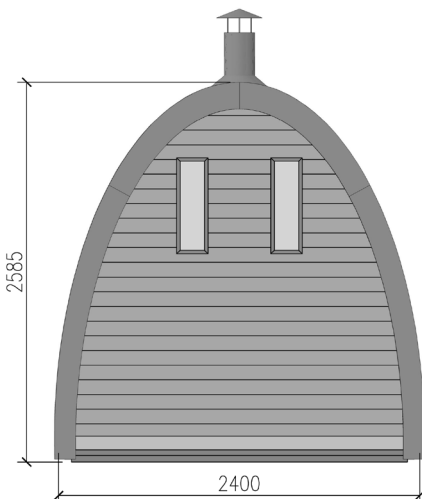

Sauna Pod

4 M

health, beauty, peace of mind

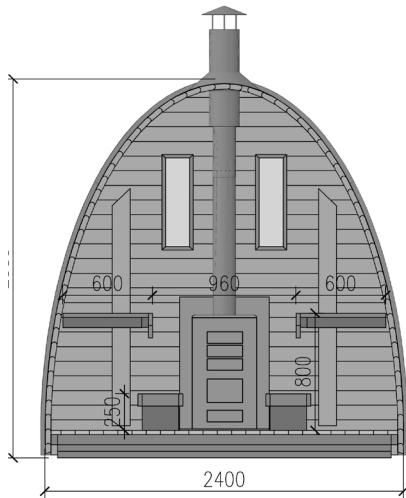
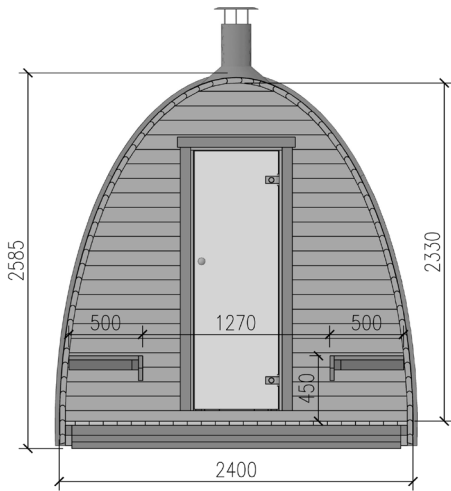
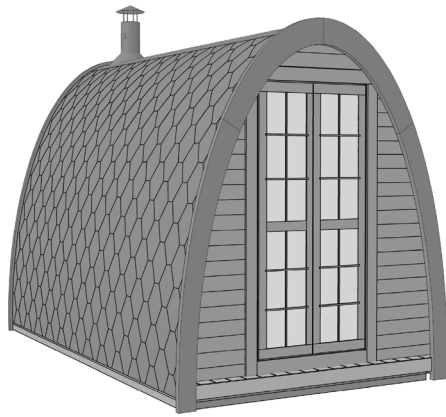

Specifications



Wood	Spruce
Shape	Pod
Inside area, m ²	9.6
Total height, m	2.6
External dimensions (WxD), mm	2400x4000
Size of dressing room (WxD),mm	2400x1500
Size of sauna room (WxD),mm	2400x2224
Number of windows	2
Weight, kg	1700
Number of persons	2-4
Assembling hour (2 people)	8
Size of windows (WxH), mm	220 x 660
Size of doors (WxH), mm	1020 x 1900
Size of sauna benches (WxL), mm	2224 x 600
Size of changing room benches (WxL), mm	500 x 1500

STANDARD SET

- Pod made from spruce wood;
- Roof covered with black bitumen shingles;
- Double doors with a lock and the double glass windows;
- Tempered glass windows in the back wall;
- Benches;
- Inside glass door;
- Heat-resistant plates for a heater;
- Safety fences;
- Two rooms inside: a sauna room and a changing room

OPTIONS

- A color of roof shingles: red, black, green;
- 8 types of heater and chimney KITS;
- Additional products can be found on page 5.

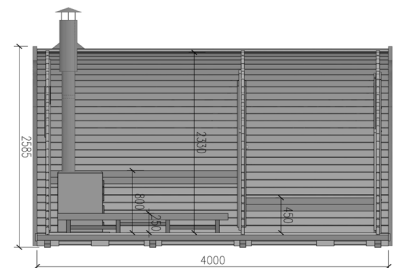
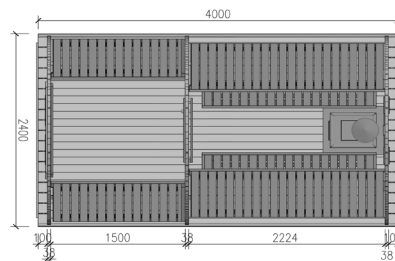

Windows and doors

Window's size is 220 x 660 mm, door's size is 1020 x 1900 mm. Double glass units and tempered glass are used; they windows ensure lower heat transfer to the outside, a lot of light coming inside, and long usage time.

Heater and chimney KITS



**ELECTRIC HEATER
HARVIA VEGA
BC80, 8KW 400V;
BC90, 9KW 400V**

Harvia Vega is an elegant heater that is easy to use. The stainless steel outer casing of the heater gives your sauna a modern look. The operating switches are placed ergonomically in the upper part, on the side of the heater, which provides easy operating. Stones and 400V connection included. The recommended size of the sauna room is 5–14 m³.



**ELECTRIC HEATER
HARVIA CLUB 13.5,
13.5KW 400V**

The floor-mounted Club electric heaters are of the world-famous Harvia quality. They are completely made of stainless steel and provide the power and durability required for heavy-duty use. The Club heaters are controlled by a separate control unit Griffin CG170. The recommended size of the sauna room is 11–20 m³.



**WOODBURNING
STOVE „HARVIA
M3“ 16.5KW**

A stylish stove for the smaller saunas. The Harvia M3 has a classic design and is suitable for the smaller wood burning saunas. A recommended size of the sauna room is 4.5–13 m³. Stones and standard chimney KIT included.



**WOODBURNING
STOVE „HARVIA
PRO 20“ 24.1KW**

With a heater Harvia 20 Pro you can have a good hot bath in the medium-sized saunas. It has a big space for stones and an air-flow spoiler made of stainless steel. A recommended size of the sauna room is 8–20 m³. Stones and standard chimney KIT included.



**WOODBURNING
STOVE „HARVIA
M3 SL“ 16.5KW)**

The SL model (outside firewood feeding) is designed for people who want to conveniently heat their sauna from an outside. Stones and standard chimney KIT included.



**WOODBURNING
STOVE „HARVIA
SL20“ 24.1KW**

The SL 20 model (outside firewood feeding) is designed for people who want to conveniently heat their sauna from an outside. Stones and standard chimney KIT included.



**STANDARD
CHIMNEY KIT**

A Standard chimney KIT is made from stainless steel. This Standard chimney can withstand 450 degrees gas. Its outer diameters is 20 cm, and inner diameter is 11.5 cm.



**„LUXURY“
CHIMNEY KIT**

A „Luxury“ chimney KIT is CE marked (under 1856-1 EN European Standardization Certificate). It is made from shiny stainless steel. It either use AISI 316 and/or AISI 304 as standards and insulation. This „Luxury“ chimney can withstand 600 degrees gas. Its outer diameters is 17 cm, and inner diameter is 11.5 cm.



Roof shingles



BITUMEN SHINGLES

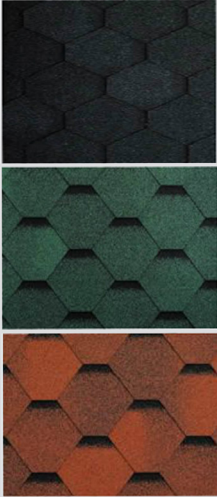

6 layer bitumen shingles are made from a durable and highly resistant fiber glass base coated with the polymer-reinforced bitumen mix which includes a high quality bitumen and an aggregate. The top layer of the shingles is covered with mineral granules ensuring the protection from UV as well as from other weather conditions. The granules are painted using a thermal method, which means that a pigment is burned-in into the surface of granules and this guarantees a long durability of the color. The bottom of the shingles is an adhesive polymer-reinforced bitumen layer protected with an easily removable silicon membrane. Due to the sun heat the overlapped tiles on the top stick to each other thus forming a double hydro-insulating layer which guarantees an excellent leak resistance of the roof. A color of the roof shingles can be chosen from black, green or red. A warranty term for the shingles is 15 years!

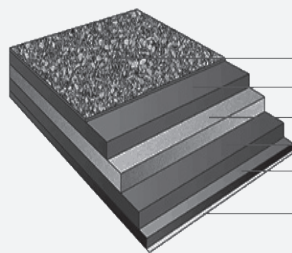

3. Top layer - mineral surfacing
2. Bitumen mass
1. Base - fibre glass
2. Bitumen mass
4. Bottom layer - adhesive polymer-reinforced bitumen
5. Protective layer - easily removed silicon membrane

Type of wood



SPRUCE



We mainly use Nordic spruce, which comes from Scandinavia. The light, golden-white softwood radiates a friendly warmth. Every single board used for our Sauna Pod has its own individual character and history, and this makes our Sauna Pod a real natural and unique product.

Transportation

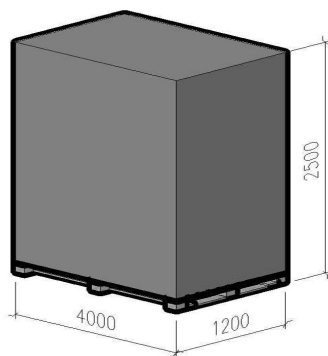

Sauna Pod KIT

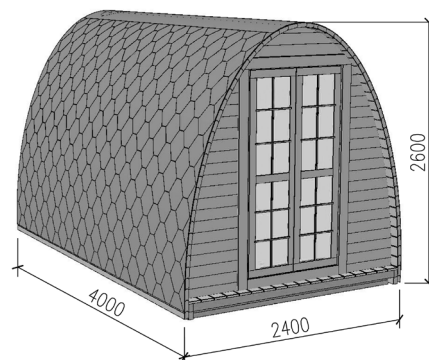

Assembled sauna pod

The Sauna Pod is delivered to a customer fully assembled or not assembled (packed on a pallet (KIT)) but fully complete. Assembly instruction of Sauna Cabin you can download and print from www.vikingindustri.com Dealer site (downloads) or email your Viking Industrier sales manager.

Accessories



WOODEN LADLE

Wooden ladle is great for sprinkling water on the stones to create a sauna steam.



HEAD REST

The elegantly designed head rest is a beautiful touch for your sauna. As well it is a comfortable accessory.



SAUNA LIGHT

Protection level IP44. Bulb E14 (max. 40 W) is not included in the delivery.



SAUNA LIGHT COVER

Beautiful wooden sauna light cover.



THERMOMETER - HYDROMETER

Thermometer - hydrometer helps you to keep an eye on both the sauna temperature and air humidity.



BACK REST

Back rest helps to sit more comfortably in the sauna. Alder or aspen wood.



CLOTHES HANGER

An excellent solution for hanging towels in the changing room. It is made from durable wood and is wall-mounted.



WOODEN BUCKET FOR WATER

Our wooden buckets are of high-quality. The plastic inner part prolongs a life of the product and makes the cleaning easy.



22 LITERS WATER TANK

The water tank (22 l) is mounted directly above the heater. The water heats up quickly because the pipe going through the tank functions as a wall of the water tank.



WOOD BURNING HEATER SAFETY FENCE

Safety fence is made from aspen or alder wood. It protects and allows to keep a proper safety distances from hot wood burning heaters.



ELECTRIC OVENS SAFETY FENCE

Safety fence is made from aspen or alder wood. It protects and allows to keep a proper safety distances from hot wood burning heaters.



SAUNA HATS

Sauna hats made from 100% wool (800 g/m²) with a place for your picture, logo or phrase.

Foundation

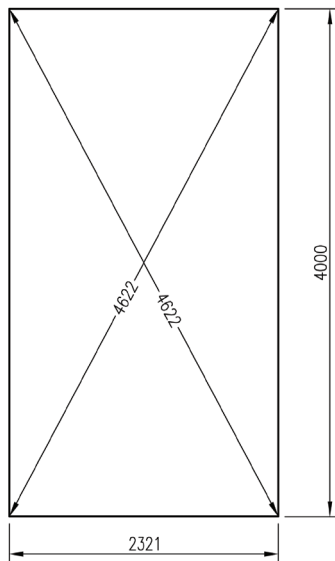

It is very important to have a proper foundation for your Sauna Pod. Therefore we recommend making the foundation according to the sketches here.

First of all, foundation must be prepared according to the landscape and ground conditions. Consult a qualified builder or an engineer to prepare a proper foundation, which fits your location. Make sure to complete the site preparation and the foundation before unpacking and assembling the Sauna Pod.

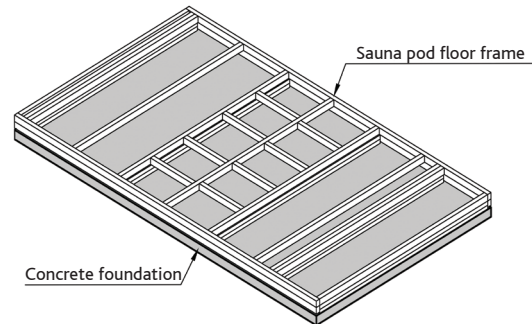

Usage



Saunas typically take 30-40 minutes to heat up. The recommended temperature is 80-90° C. The thermometer should be located at head level in the sauna. It should be located away from the heater or the door so it will not give a false reading.

Enjoy the many health benefits of relaxing heat in your own Sauna Pod just remember that staying in the hot Sauna for long periods of time makes the body temperature rise, which may be dangerous. The recommended time inside a Sauna Pod is from 10 to 15 minutes. Take a five-minute break and then repeat. Also you should keep safety instructions and keep away from the stove when it is hot. Never throw water on the stones when there are people near the stove, because hot steam may burn

their skin. Be very careful when moving in the Sauna, as the benches and floors may be slippery. Do not hang clothes to dry in the Sauna, as this may cause a risk of fire.

Also check your body for any metal (jewelry and zippers, for example) in order to prevent it from burning your body when it quickly heats up in the facility.

We strongly recommend shouldn't use the Sauna to pregnant women and neither should young children.

Maintenance



As wood is a natural material, it can change through time. Cracks of various sizes, changes of the color as well as a structure of the wood are not the errors, but a feature of a wood.

Natural wood (not impregnated) becomes grayish after having been left untouched for a while. Later it can turn blue and get covered with the mold. Therefore, you should immediately impregnate the wood to protect the products.

We strongly recommend that you impregnate the door and windows with a wood impregnation agent both the inside and outside of them, because the doors and

windows can become twisted otherwise. In general, we recommend consulting a specialist regarding the paints suitable for an unprocessed softwood and follow the manufacturers' of paints instructions. Properly painting the Sauna Pod will extend its lifetime. Besides that, we suggest you thoroughly inspecting the Pod every six months and checking if it needs re-painting or else.

It's NOT advisable to paint the Sauna walls before assembling it – this is best done when the Sauna Pod has been already assembled and when the weather is fine. However, if you wish to paint some parts in different colors, this should be done before the Sauna is assembled.