



# CONTENTS

<b>1.</b>	<b>Product information</b>	<b>4</b>
1.1.	Content of the package	4
1.2.	Accessories	4
1.3.	Application	4
1.4.	Function - with temperature sensor activated	5
1.5.	Function - with temperature sensor deactivated (ventilation)	5
1.6.	Shipping	5
1.7.	Warranty	5
<b>2.</b>	<b>Setup</b>	<b>6</b>
2.1.	Mounting	6
2.2.	General use of the control panel	8
2.3.	Generally add/delete devices	10
2.4.	Add/pair with Power Unit	12
2.5.	Test of communication/signal	17
2.6.	Signal test	17
2.7.	Language selection	18
2.8.	Lighting and operation	19
2.9.	Refire and Afterrun	20
2.10.	Turn off the chimney fan	20
2.11.	Ventilation	21
2.12.	System control	22
2.13.	Weather station	22
2.14.	Pairing with smartphone via Bluetooth	23
2.15.	Basic features of the app	28
2.16.	Ventilation with the app	32
2.17.	Weather station in the app	33
2.18.	Setup and history in the app	34
2.19.	FAQ in the app	38
2.20.	Software update	40
<b>3.</b>	<b>Accessories - Repeater</b>	<b>41</b>
3.1.	Setup - Mounting	41
3.2.	Range	41
3.3.	Setting up one repeater	41
3.4.	Technical data	42
<b>4.</b>	<b>Accessories - XTP sensor</b>	<b>43</b>
4.1.	Setup - Mounting	43
4.2.	Electrical connection	43
4.3.	Add device/pairing devices	44
4.4.	Technical data	44
<b>5.</b>	<b>Technical specifications</b>	<b>45</b>
5.1.	Troubleshooting	45
5.2.	Technical data	46
5.3.	User and service menu	47
<b>6.</b>	<b>Declaration of Conformity</b>	<b>49</b>

If you want to have an overall view of yours units' ID number and password, they can be written down here

Type	ID no.	Password
Pairing card (pin code)		
Control panel		
Power Unit ID		
Control panel serial no. *		

The serial number is located on the back of the control panel.

## Signature explanation

The following terms are used in this manual to draw attention to potential risks or important product information:



### Danger

Violations of directions indicated by a prohibition symbol are associated with a danger to life.



### Warning

Violations of instructions indicated by a hazard symbol are associated with the risk of personal injury or damage to the equipment.



### Danger



To reduce the risk of fire, electric shock or personal injury, observe the following:

1. Use the device correctly as illuminated manufacturer. If you have any questions please contact your dealer
2. Before servicing unit:  
Disconnect the power and make sure no one can accidentally reconnect
3. Installation work should be carried out by competent persons and in accordance with applicable national rules
4. Follow the device's instructions from the manufacturer and general safety instructions
5. This unit must be connected to ground in the installation

### Disposal

No special precautions. The product should be disposed of in accordance with national rules for the disposal of electronic waste.

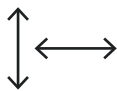
## Illustration explanation

Illustration	Explanation
	Light pres incl. movement on the touch screen. To the sides or up and down
	Light pres on touch screen

# 1. Product information

## 1.1. Content of the package

- 1 pcs. control panel Xzense
- 1 pcs. Power unit for mounting on chimney
- 1 pcs. temperature sensor
- 1 pcs. bracket / wall mount
- 1 pcs. bag with two raw plugs and two screws for fitting
- 1 pcs. USB micro charging cable
- Installation and operating instructions
- Quick guides
- Pairing card (pin code) with code for pairing control panel and control box

## 1.2. Accessories

**Additional accessories can be ordered separately**

exodraft item number	Item	Description
7501001	Repeater	If there is a need to have a Power Unit and Control panel located at a distance that excludes signal between the units, it is possible to amplify the signal with a repeater.
7501002	XTP-sensor (Pressure sensor)	With a wireless XTP sensor, it is possible to keep a constant draft in the chimney without having to adjust the speed of the chimney.
7501004	USB-charger	If there is a constant supply for the control panel, for example. In connection with operation via an App from a smartphone, this requires a USB charger.
1100703	Fittings for mounting on the steel chimney	If the Power Unit is to be mounted on a steel chimney, a mounting kit can be purchased
5220000	Additional control panel	If you want to be able to control the chimney fan from several control panels, several can be connected to the same system

## 1.3. Application

**exodraft** wireless Xzense control, together with an **exodraft** chimney fan, is designed for use with fireplaces, stoves and solid fuel boilers.

Xzense can start the chimney fan automatically by means of the temperature sensor, but can also be started by using the control panel. The temperature sensor monitors the fireplace and informs when to add more fuel. When the temperature drops further, the chimney fan goes out. A simple programming of the control makes it possible to use Xzense optimally, together with either an open fireplace or a stove/boiler.

Xzense also allows you to warn against excessive temperature in the chimney.

### Ventilation

The controller can be used to regulate the chimney fan, even without heat in the fireplace, if it is desired to ventilate the room.

## 1.4. Function - with temperature sensor activated

<b>Start-up function</b>	Xzense is activated by pressing the button at the top of the control panel. The lightning function is selected before lighting the stove/fireplace. The chimney fan now starts at the starting speed, <i>boost</i> . After a preset time, the speed is adjusted down to a lower set level. The factory setting for boost speed is 100% for 10 min.
<b>Automatic startup</b>	If you forget to start the chimney fan before lightning, the chimney fan will automatically start when the temperature reaches the set start temperature at the sensor. The factory setting is 40°C.
<b>Refiring function</b>	The Xzense control panel indicates when it is time to add new fuel. The display lights up and a dialog box comes up while giving an alarm beep. If you want to refire, select the YES button. Then you fire up further by adding more fuel to either its fireplace or the stove. When you say YES to refiring, the chimney fan creates a maximum boost for 3 minutes, after which it regulates the speed down again.
<b>Automatic stop</b>	After the last firing, the temperature of the chimney will slowly drop. When the temperature has dropped to the factory default setting, the controller ensures that the chimney fan stays in operation for a while, to ensure that the last smoke is pulled out, also called <i>Afterrun</i> . The factory setting for <i>Afterrun</i> is 30 min.
<b>High temperature warning</b>	The control panel display will light and an alarm tone (5 beeps) will sound if the temperature of the temperature sensor exceeds the set value. The factory setting is 330°C. Pressing the control panel screen will turn off the sound immediately.
	All factory settings can be changed and found under the <i>Setup</i> menu.

## 1.5. Function - with temperature sensor deactivated (ventilation)

<b>Ventilation</b>	If the temperature sensor is not activated in the user menu, the control can be used as a 10-100% regulation of the speed of the chimney fan. Thereby ventilation from the room can be achieved.
<b>Note</b>	Automatic start and stop is also disabled if the temperature sensor is disabled.

## 1.6. Shipping

<b>Shipping</b>	Xzense is sent in secure packaging, along with the Power Unit, with accompanying instructions.
<b>Standard packing list</b>	If other components are included, these will appear as separate items on the shipping package list.

## 1.7. Warranty

**exodraft**-products must be installed by qualified personnel. If this is not complied with, exodraft a/s may claim the right to have the product warranty lapsed wholly or partly.

**exodraft** reserve the right to make changes to these guidelines without prior notice.

## 2. Setup

### 2.1. Mounting

**Sending signals**

Place the Power Unit on the chimney so that the most direct line can be reached. The Power Unit and the chimney fan must have a maximum distance of 1 meter, so that the cables can reach.

**Range**

The range between the units should not exceed 18 meters if you want the most optimal signal. Please note that some constructions may have the smallest scope, including storey buildings, concrete and steel buildings.

**Signal**

The repeater makes it possible to obtain a signal if there is too much distance between the control panel and the Power Unit or if the signal has to pass through, for example, several storeys. The signal can at most go through 3 pcs. repeater between an Xzense Power Unit and a control panel. The repeater is placed between the Xzense control panel and the Power Unit, which is typically mounted on the chimney. In some situations, it would be appropriate to set up the repeater outdoors, e.g. under the overhang or on another building. The signal may have difficulties penetrating certain materials, such as steel and aluminum structures.

**Mounting of sensor and Power Unit**

Step	Action	Illustration
1a	Install the sensor on the chimney fan with the supplied bracket. Drill 2 pcs. 4 mm holes and insert the screws.	<p>The illustration shows two views of a sensor being mounted on a chimney fan. On the left, labeled 'RS', a sensor is attached to a bracket which is being positioned over the fan. On the right, labeled 'RSV', the sensor is shown fully installed on the fan's surface.</p>
1b	<b>Mounting with cover flange:</b> Remove the plug from the tube cover flange, and insert sensor. Tighten the screw (A).	<p>The illustration shows two views of a sensor being inserted into a cover flange. On the left, a screw labeled '(A)' is being used to secure the sensor in place. On the right, the sensor is fully seated within the flange.</p>
2a	<b>For brick chimneys:</b> Drill holes as shown (max. 1 m from the chimney fan). Remove the lid from the power unit and mount it on the chimney using rawlplugs and screws.  Note: Position the device where it has the best line of sight to the control panel.	<p>The illustration shows a power unit being mounted on a brick chimney. The unit's lid is removed, and it is secured to the brickwork with rawlplugs and screws. Dimensions are indicated: a horizontal distance of 110 units and a vertical distance of 90 units from the fan area. The Xzense logo is visible on the side of the unit.</p>

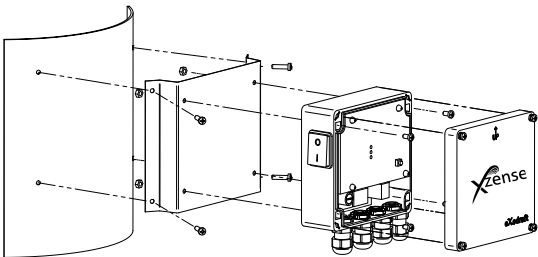
Step	Action	Illustration
2b	<p><b>For steel chimneys:</b> Remove the lid from the power unit and mount the bracket (optional extra) using screws and nuts. Drill 4 mm holes in the chimney and mount the device using selftapping screws (max. 1 m from the chimney fan).</p> <p>Note: Position the device where it has the best line of sight to the control panel.</p>	

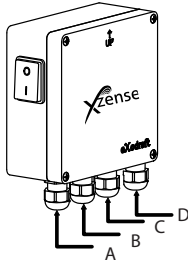
3	<p>Connect the wires according to the diagram at the bottom.</p> <p>A: Supply voltage (cable with plug attached).</p> <p>B: Connection to a chimney fan.</p> <p>C: Building automation</p> <p>D: Connection to temperature sensor.</p> <p>When installing cables, wires should be used be approx. 8 cm free of the jacket. Note: There must be no power on device when connecting wires.</p>	
---	--	---

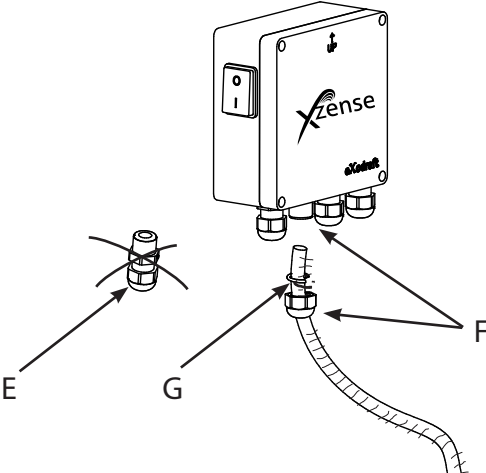
4	<p>Attaching armoured hose from chimney fan.</p> <p>E: Remove the screw connector from the armoured hose. Keep the small plastic clamping ring!</p> <p>F: Fit the nut from the connector from the power unit.</p> <p>G: Fit the plastic clamping ring on the armoured hose.</p> <p>Attach the armoured hose to the power unit.</p>	
---	--	---



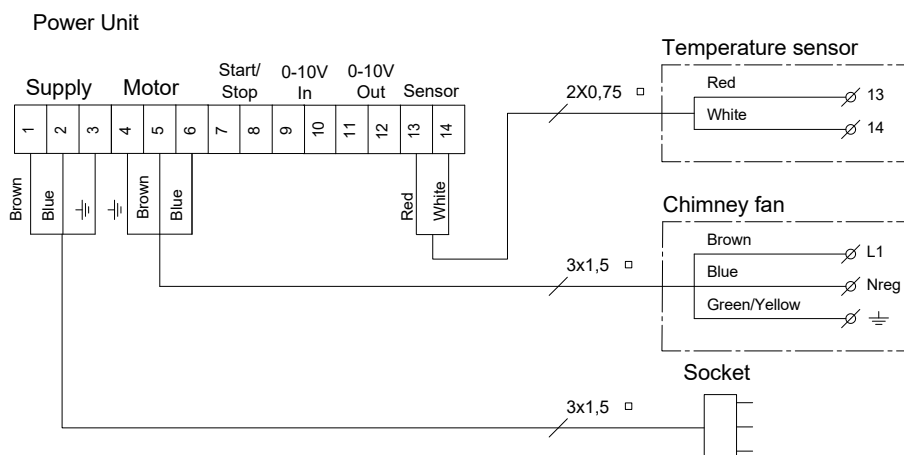

### Wiring diagram



Note: From the temperature sensor, the two red wires in terminal 13 and the two white in terminal 14.

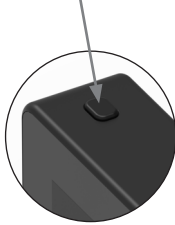
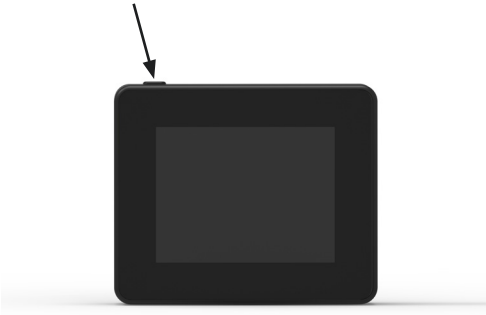

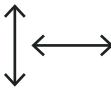
## 2.2. General use of the control panel

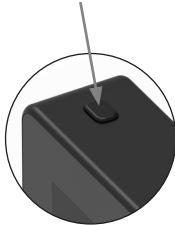
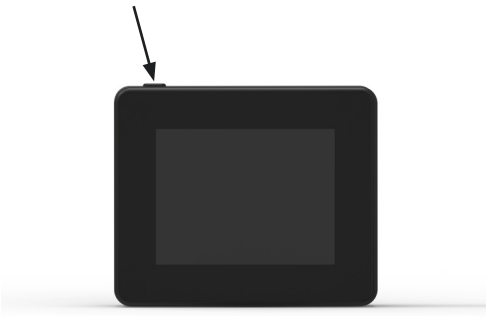
### Function of buttons and touch screen

Action	Illustration	Example
<p><b>Display activation</b>                      Press the button on the top with one click to activate the display.                      The control panel is activated when it lights up.</p> <p>The control panel goes into standby/deepsleep by pressing the button once more while the display is on. After approx 10 seconds, the display will even go into the deepsleep if there is no activity on the display.</p>		
<p><b>Tap lightly</b>                      Tap a finger to navigate the menus, or to change the values of the properties</p>		
<p><b>Scroll</b>                      Move a finger (up/down or to the sides) across the screen without lifting it, to scroll up and down/back and forth in the respective drop-down menus</p>		
<p><b>Restart or switch off the control panel</b>                      To restart the control panel, hold down the button for approx 4 sec.                      A dialog box appears and asks if you want to restart the control panel.</p> <p>If you want to switch off its panel completely, res the button for more than 10 sec.                      To reactivate the panel, it needs to be powered by a USB-charger.</p>		



## Charging and battery



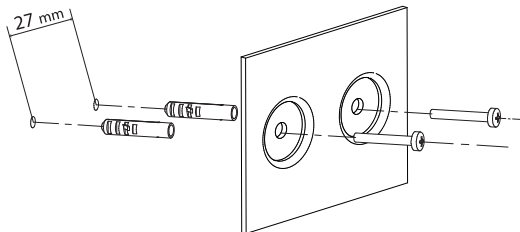
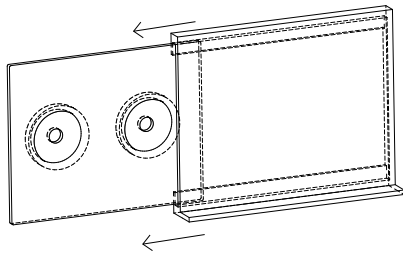
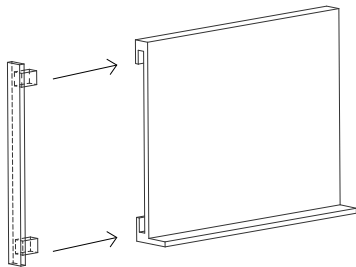

Action	Illustration	Example
<p><b>Charging with USB cable</b>                      To charge the control panel, use the USB connector at the bottom. A charge from the entire discharged state takes approx 4-5 hours.</p> <p>The control panel has a service life of approx 30 days of normal use with deactivated bluetooth communication for a smartphone*.</p> <p><i>*It is recommended that the control panel charger plug is always used when Bluetooth is enabled as the life of the battery is significantly reduced when using the smartphone and the bluetooth function.</i></p>		

## Mounting of control panel

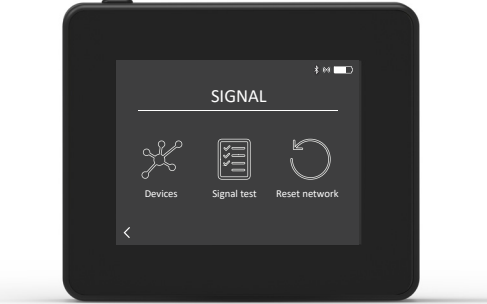

Step	Action	Illustration
1	<p>Mark the distance on the wall from the steel plate.</p> <p>Drill 2 holes with a diameter of 6 mm                      Insert rawlplugs and mount the steel plate in the two holes with two screws.</p>	
2	<p>Slide the plastic bracket outside the steel plate</p>	
3	<p>Fit the stop at the end of the bracket</p> <p>The Xzense control panel can now be placed on the wall bracket</p>	

## 2.3. Generally add/delete devices

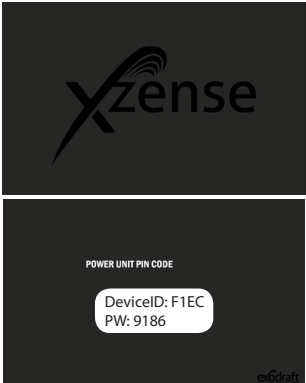
### Add devices

Step	Action	Display
1	To add a device (Power Unit, repeater, etc.), select the Add Device menu.	
2	Already paired devices are displayed on the screen with a trash can beside.  To pair with a new device, select a device with a link beside.	
3	If the desired device you want to pair with is not available, you can add the device via. code-pairing.  Select the Add Device feature +.	
4	If you want to pair with a Power Unit, you must enter the correct code from the pairing code card that came with the Power Unit.  Use the arrows to navigate the numbers and use the plus and minus icons to increase or decrease the value of the number. Finish with OK.	
5	The code consists of four characters. Number from 0-9 and/or letters from A-F.*  <i>*The password illustrated to the right is just an example.</i>	



## Delete paired devices

Step	Action	Display
1	If you want to delete a paired device, select the waste bin icon to delete the pairing.	
2	A dialog box appears, and you finally confirm with YES if you want to delete the pairing to the device.	

## 2.4. Add/pair with Power Unit

It is possible to pair the control panel and Power Unit in four different ways.

### Option 1 - With power within two minutes

Step	Action	Display
1	<p>Within the first two minutes after the power is connected to the Power Unit, the control panel can be connected without the use of ID or code. The connection can thus be made by using <i>Add device</i>, which is found in the start menu.</p>	
2	<p>Select the Power Unit with the correct ID under units. The ID number can be found on the pairing card enclosed with the Power Unit.</p>	
3	<p>If the connection has been made correctly, the control panel will report the pairing again.</p>	

## Option 2 - With power and supplied code

Step	Action	Display
1	<p>If the Power Unit has been connected to power for more than two minutes, then the pairing must be done using the password supplied with the Power Unit.*.</p> <p><i>*The password illustrated to the right is just an example.</i></p>	
2	<p>The connection can thus be made by using <i>Add device</i>, which is found in the start menu.</p>	
3	<p>Select the Power Unit with the correct ID under units. The ID number can be found on the pairing card enclosed with the Power Unit.</p>	
4	<p>Then enter the supplied code and end with OK. If the connection has been made correctly, the control panel will announce that the pairing has been completed.</p>	

**Option 3 - With power and press button in Power Unit**

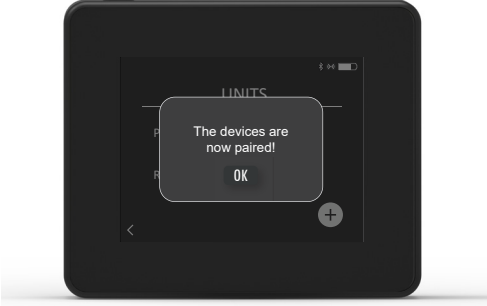
Step	Action	Display
1	If the Power Unit has been connected to power for more than two minutes and the password has been lost, then the pairing can be done by pressing the connection button inside the Power Unit for approx 5 seconds (see illustration on next page - under the <i>Power Unit</i> section).	
2	The connection can thus be made by using <i>Add device</i> , which is found in the start menu.	
3	Select the Power Unit with the correct ID under units. The ID number can be found on the pairing card enclosed with the Power Unit.	
4	If the connection has been made correctly, the control panel will report the pairing again.	



## Power Unit

### Features

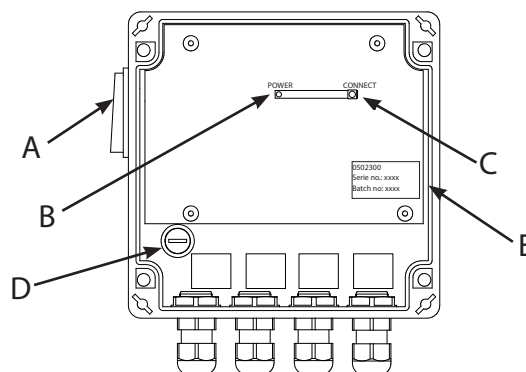
- A Switch for the Power Unit/chimney fan.
  
- B LED indicators:  
**POWER** lights up continuously when voltage is applied to the Power Unit.  
**CONNECT** lights up when searching for a device.
  
- C Button to connect:  
 The control panel and Power Unit can be connected.  
 Press the button (C) on the Power Unit for more than 5 sec.  
  
Note: the search may take up to 2 min.
  
- D Fuse: Secure the chimney fan against overload.
  
- E The Power Unit serial number (located on the inside of the box)



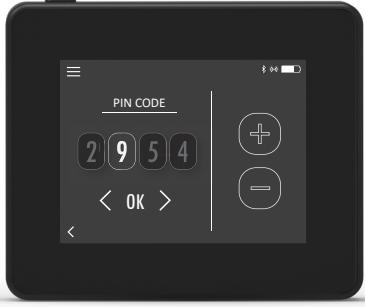

### Option 4 - Not visible device and provided code



Step	Action	Display
1	<p>If the Power Unit is switched on and is not visible on the overview, a pairing can take place using the ID and password the Power Unit is supplied with. The connection can thus be made by using <i>Add device</i>, which is found in the start menu.</p>	
2	<p>Choose <b>+</b> (<i>Add device</i>) in the lower right corner.</p>	
3	<p>Then enter the supplied ID and the supplied code. Exit with OK. If the connection has been made correctly, the control panel will report the pairing again.</p>	



## 2.5. Test of communication/signal





Step	Action	Display
1	<p>Turn on the control panel by clicking the button on the top.</p> <p>Plug in the USB-cable if needed.</p>	
2	<p>The screen now lights up on the home screen.</p> <p>If the display shows the text "No connection to Power Unit", there is no strong signal connection. Try moving the control panel for better contact.</p> <p>See the section on Setup - Mounting, for more information.</p>	
3	<p><b>When mounting and signal errors</b></p> <p>If you want to mount the wall bracket in order to have a station for the control panel, it must be ensured that the unit can receive signal from this location.</p> <p>Always check if there is a signal before mounting, by pressing the signal icon under the Signal Test.</p>	

## 2.6. Signal test

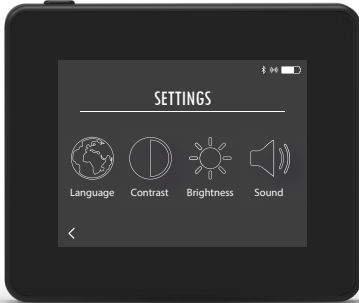

Step	Action	Display
1	<p>To test the signal strength, enter the Signal Test menu, which is available using the following menu:</p> <ol style="list-style-type: none"> <li>1. General</li> <li>2. Network</li> <li>3. Communication</li> <li>4. Signal test</li> </ol>	
2	<p>Press the signal icon and the test starts.</p> <p>The display sends 100 data packets out, and responds them back to the unit. The more packets sent back, the better the signal is right where the control panel is located or located compared to the repeater.</p> <p>If there are many data packets left, the signal is bad and you should find a better place for its control panel.</p>	

## 2.7. Language selection



At factory settings, *english* is selected as the default setting.  
It is possible to change the language in the menu, for the control panel.

Step	Action	Display
1	Turn on the control panel by clicking the button at the top. Select the top menu <i>General</i> .	
2	Select the menu <i>Interface</i>	
3	Select the menu <i>Language</i>	
4	Select the desired language by moving your finger to the side of the language menu. Click on the desired language.  To return to the menus, use the back arrow at the bottom left corner.	

## 2.8. Lighting and operation

Step	Action	Display
1	Select <i>Lighting</i>	
2	<p>The display shows a lighting, and the fireplace/stove must now be turned on.</p> <p>The chimney fan will run at maximum speed for 10 minutes (default setting) and then fall to the speed it was driving when it was last turned on. The Boost period and speed can be changed in the Setup menu.</p>	
3	<p>Turn on while the chimney fan is running at maximum speed.</p> <p>If the temperature sensor is activated and you forget to turn on the chimney before turning on, the chimney fan will automatically start when the temperature at the top of the chimney has reached the start temperature setting. The factory setting is 40 °C.</p> <p><b>Note: We recommend that the chimney fan be switched on manually every time! At the same time you avoid soot and ash to escape the fireplace/stove during lighting.</b></p>	
4	<p>After the boost period, it switches on in operation mode.</p> <p>To increase or decrease the chimney speed and hence the chimney draft, the up and down buttons are used. The display shows the new setting.</p>	
5	<p>The display automatically goes into sleep mode and the backlight goes out after a short time. Press the button on the top of the unit to turn the display back on.</p>	

## 2.9. Refire and Afterrun

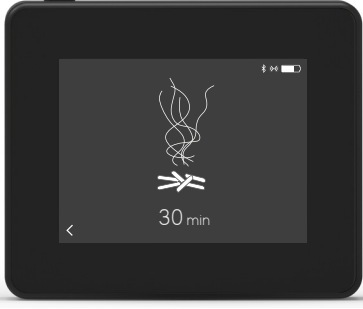
Step	Action	Display
1	<p>When it's time to refuel, the display lights up, a small alarm sounds and a dialog pops up and asks if you want to refire.</p> <p>It is possible to turn on the alarm signal in the menu <i>Settings</i>.</p>	
2	<p>If you want to <i>Refire</i>, press <i>YES</i> in the dialog box before refire.</p> <p>In order to avoid soot and smoke in the room, the chimney fan speed is increased to maximum (boost) for 3 minutes before falling back to the previous setting.</p>	
3	<p>If you do not want to re-fire, <i>NO</i> is selected and the <i>Afterrun</i> will start.</p> <p>The afterrun has a factory setting of 30 minutes.</p>	

## 2.10. Turn off the chimney fan



Step	Action
A	<p>Manual: The chimney fan is switched off by pressing the switch off.</p> <p>Note: If the temperature sensor is activated, the chimney fan cannot be switched off as long as the temperature at the chimney fan is higher than the stop temperature setting.</p>
B	<p>Automatic: After the last refiring, the temperature in the chimney falls slowly. If the temperature sensor is add the chimney fan automatically stops when the temperature in the chimney has fallen below the stop temperature. The factory setting is 35 °C.</p> <p>The chimney fan has a Afterrun period of 30 minutes, which ensures that the fuel is glow-free and that the remaining smoke has been led away from the chimney. Both the stop temperature and the afterrun period can be changed in the menu.</p>

## 2.11. Ventilation

The chimney fan can also be used when there is no fire in the fireplace/stove.



The chimney fan can ventilate the room or make sure that soot and dust particles are sucked away while the fireplace is being cleaned.

When the chimney is cleaned, the chimney fan must also be cleaned.

Step	Action	Display
1	Select the function <i>Ventilation</i> , to make a ventilation without a lighting.	
2	Start the chimney fan by press the <i>Start</i> -button.	
3	To increase or decrease the speed, use the buttons to adjust with. The display shows in percentage how fast it is running.  Turn off the chimney fan by pressing <i>Stop</i> .	

## 2.12. System control



The control panel can be set for various control systems - manual use, exotelligence or pressure control.

Type	Icon	Description
Manual		By manual use, you manually adjust the speed of the chimney fan during operation. This means that after the boost period, the chimney fan runs down to the last used operating speed and stays there until the control panel is adjusted. It can be regulated within the range of 10-100%, depending on how much feature you want to create.
eXotelligence*		eXotelligence is an intelligent function that creates data measured in the control after one or more firings. This function ensures that it is the most optimal ignition and operation, based on how you have previously switched on and operated. Turning this function on enables the controller to drive the speed up and down, depending on the indoor and outdoor temperature, air pressure and chimney temperature. For eXotelligence to work, it requires the Power Unit to be outdoors and not directly in sunlight.
Pressure controlled		To be able to run with Pressure controlled system, it requires one purchased an XTP sensor. Rather than having to regulate the chimney speed.

\*If you want to know more about eXotelligence, you can find more information on our website [www.xzense.com](http://www.xzense.com)

## 2.13. Weather station

In the weather station on the control panel you can see the conditions for the weather on the given day/firing.

Type	Icon	Description
Outdoor		The Power Unit has a built-in temperature sensor, which is used to indicate the outdoor temperature on the control panel. Since the Power Unit can sit directly in the sunlight, the temperature may difference from the correct outdoor temperature, which is normally measured in the shade.
Chimney		The supplied temperature sensor for installation under the chimney fan is used to indicate the flue gas temperature.
Air pressure		The Power Unit has a built-in air pressure gauge designed to measure atmospheric pressure. It is this pressure that is stated under air pressure measured in hPa.

## 2.14. Pairing with smartphone via Bluetooth

The control panel can be paired with a smartphone (iOS and Android) if you want to operate the chimney by using an app. Download the app Xzense in your application store on your smartphone.

It is recommended that the control panel charger plug is always used when Bluetooth is enabled, as battery life is significantly reduced when using the smartphone and the Bluetooth function.

### Control panel

Step	Action	Display
1	Turn on the control panel by clicking the button at the top. Select the <i>General</i> menu in the left corner.	
2	Select the function <i>Network</i>	
3	Select the function <i>Bluetooth</i>	
4	Turn Bluetooth on by pressing the <i>OFF</i> button - It then switches to <i>ON</i> .	
5	To see the control panels ID and PIN, you can tap the large Bluetooth icon and a dialog box will appear with the information.	

## App

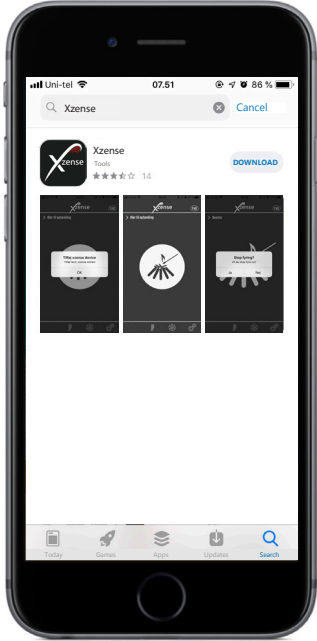
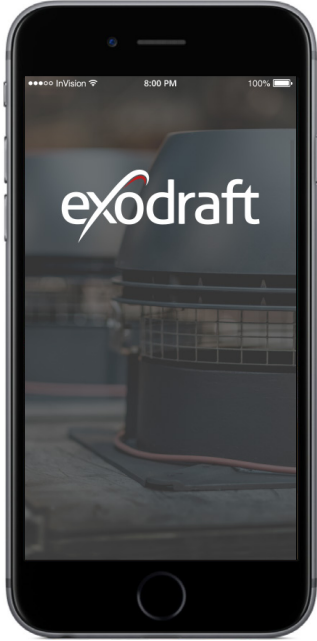
Step	Action	Display*
1	Get the Xzense app on your smartphone	
2	Open the Xzense app on your smartphone	

*\*On the next pages it is an iPhone that is illustrated, but the app can also be used on an Android smartphone.*



- 3 The app will start searching for one Bluetooth connection to your control panel  
- Remember to turn Bluetooth on both your smartphone and your control panel.

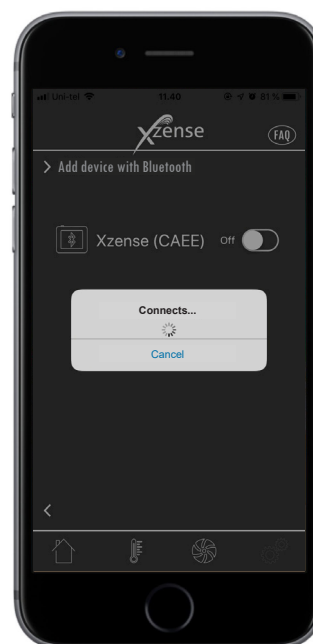

- 4 Select OK to add/pair your control panel with your smartphone.

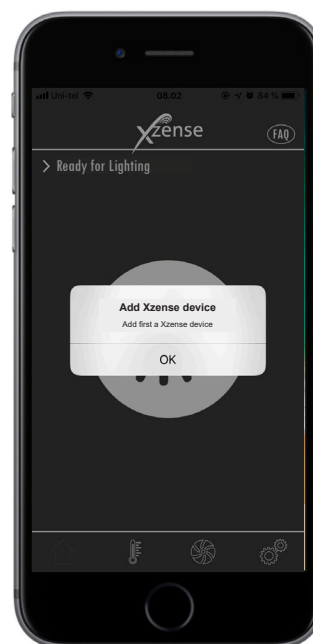

5

Activate the pairing by selecting *ON* on the control panel you want to pair with. The control panel ID is seen in parentheses after the Xzense text.  
Eg. Xzense (CFEE)



6

Enter the code and finish with OK.

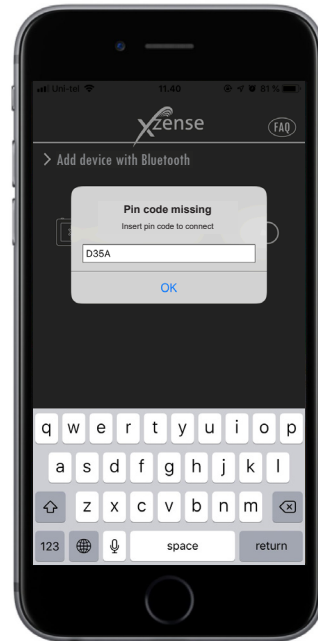



- 7 The app is now paired with the control panel - and you can now make a lighting by using your app.



## 2.15. Basic features of the app

Please note that the app's functions can only be used if the control panel is connected. The control panel and app will synchronize with each other along the way.

### Lighting

Step	Action	Display
1	Press the lighting icon to start the boost function.	
2	<p>The boost period starts and runs in the time interval the control panel is on. At the factory setting, the boost period is set 10 min.</p> <p>Make sure to turn on during the boost period - ie. when The chimney fan runs at maximum speed.</p>	

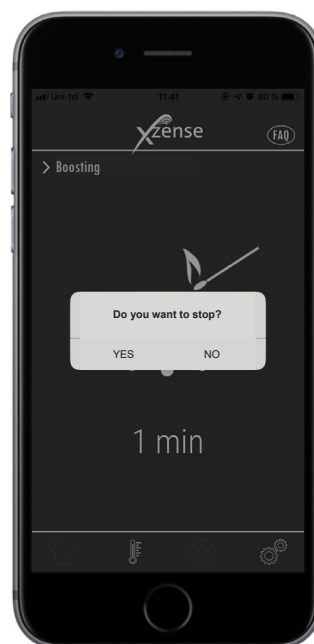

- If you ignite the lighting, you can click on the lighting icon during the boost period.
- 3 A dialog box appears. Press YES to stop firing.  
Press NO if you do not want to stop lighting/firing.

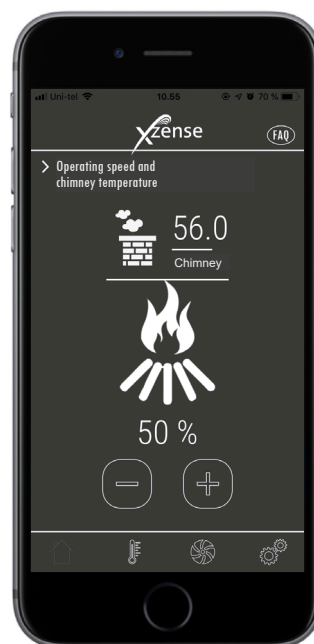

- After the boost period, it switches on in operation.
- 4 To increase or decrease the chimney speed and hence the chimney draft is used up and down buttons.



## Refiring and Afterrun

Step	Action	Display
1	<p>When it's time to refuel, your smartphone lights up. The control panel also lights up and a small alarm sounds.</p> <p>A dialog box appears on both screens and asks if you want to refire.</p> <p>It is possible to turn off the alarm signal on the control panel in the <i>Settings</i> menu.</p>	 <p>The image shows a smartphone screen with the 'xzenze' app interface. At the top, there's a status bar with 'Uzo-16', '10:55', and '70%' battery. Below the status bar, the app title 'xzenze' and a 'FAQ' icon are visible. A 'Refire' header is present. The main content area features a large graphic of crossed logs with a small fire at the base. A white dialog box is centered on the screen, containing the text 'Refire' and 'Do you want to refire?' with 'YES' and 'NO' buttons. At the bottom, there are three icons: a chimney, a fan, and a gear.</p>
2	<p>If you want to refire, press YES in the dialog box before refiring.</p> <p>To avoid smokes in the room, increase the chimney fan speed to maximum output in 3 minutes before falling back to the previous setting.</p>	 <p>The image shows the same smartphone screen as above, but the dialog box is no longer present. The large graphic of crossed logs with a fire is now more prominent. The rest of the interface, including the status bar, app title, and bottom icons, remains the same.</p>

3

If you do not want to refire, choose the *NO* function and the Afterrun will start.

The Afterrun has a factory setting with time period of 30 min.



## 2.16. Ventilation with the app

The chimney fan can also be used when there is no fire in the fireplace/stove.

The chimney fan can ventilate the room or make sure that soot and dust particles are sucked away while the fireplace is being cleaned.

When the chimney is cleaned, the chimney fan must also be cleaned.

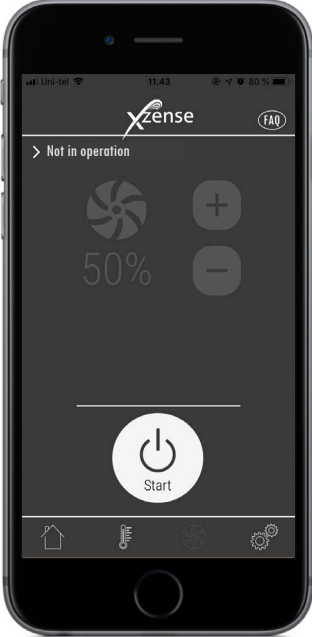
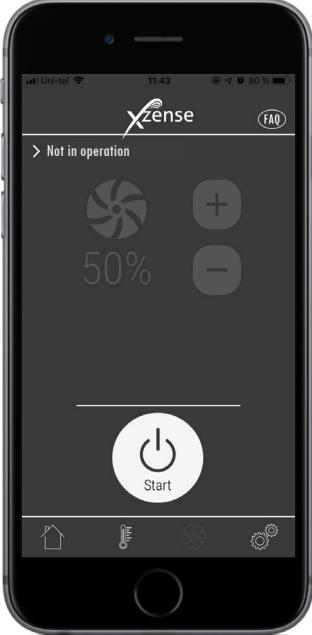
Step	Action	Display
1	Select the <i>Ventilation</i> function to make a ventilation without a lighting.	
2	Start the chimney fan by pressing the <i>Start</i> button.	



3

To increase or decrease the speed, use the buttons to adjust with. The display shows in percentage how fast it is running.

Turn off the chimney fan by pressing *Stop*.

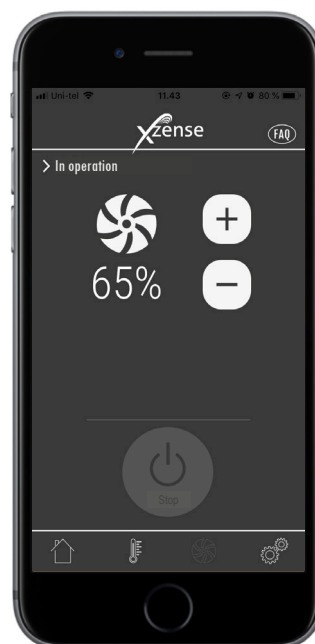

## 2.17. Weather station in the app

Also, as on the control panel, you also have the Weather Station on the app.

Select the *Weather* function at the bottom of the menu to get an overview of temperatures and air pressure at the given time.

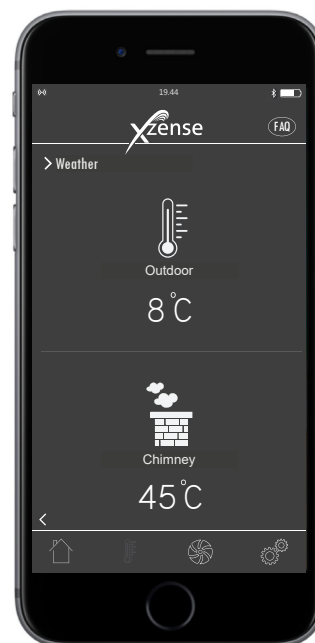

## 2.18. Setup and history in the app

### Bluetooth

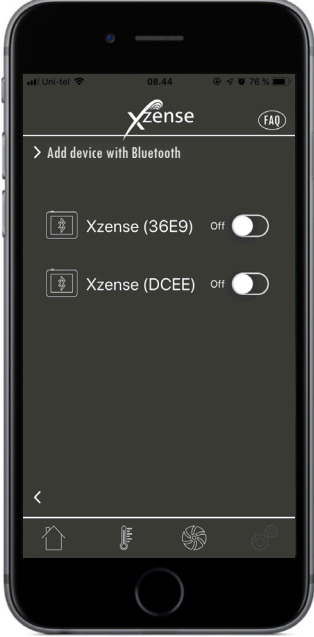
Step	Action	Display
1	Select the <i>Settings</i> option in the bottom menu. Select <i>Bluetooth</i> .	 <p>The screenshot shows the Xzense app main menu. At the top, there is the Xzense logo and an FAQ icon. Below the logo, there are three main menu items: 'Bluetooth' with a Bluetooth symbol, 'System control' with a gear-like icon, and 'History' with a document icon. At the bottom, there is a navigation bar with four icons: Home, App, Camera, and Settings.</p>
2	The overview in the Bluetooth menu shows which devices your smartphone can connect to.	 <p>The screenshot shows the Bluetooth settings screen in the Xzense app. At the top, there is the Xzense logo and an FAQ icon. Below the logo, there is a title 'Add device with Bluetooth' with a right-pointing arrow. Underneath, there are two device entries, each with a Bluetooth symbol, the device name, and a toggle switch. The first entry is 'Xzense (36E9)' with the toggle set to 'off'. The second entry is 'Xzense (DCEE)' with the toggle set to 'on'. At the bottom, there is a navigation bar with four icons: Home, App, Camera, and Settings.</p>

## System control

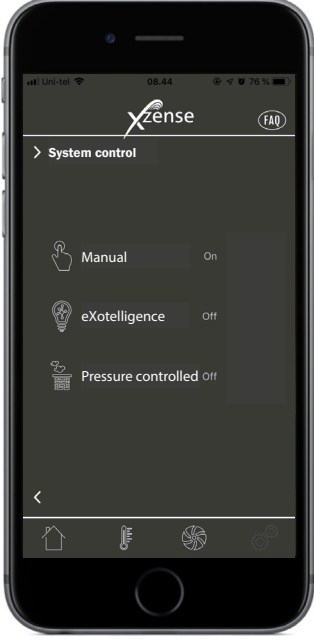
Step	Action	Display
1	Select the <i>Settings</i> option in the bottom menu. Select the <i>System control</i> menu.	 <p>The screenshot shows the Xzense app interface. At the top, the status bar displays 'Uni-tel', signal strength, Wi-Fi, time '11:44', and battery '80%'. The app header features the 'Xzense' logo and a 'FAQ' button. The main content area contains three large, vertically stacked icons: 'Bluetooth' (a Bluetooth symbol), 'System control' (a gear-like icon), and 'History' (a document icon). At the bottom, there is a navigation bar with four icons: a home icon, a gear icon, a camera icon, and a settings icon.</p>
2	<p>The screen now shows an overview of which control system the control panel can run with - and which one is selected for the device.</p> <p>To change the control system, this must be done directly from the control panel. See detailed review in "2.12. System control" on page 22.</p> <p>Changing the system control on the control panel will also effect the change on the app.</p>	 <p>The screenshot shows the 'System control' screen within the Xzense app. The status bar at the top shows 'Uni-tel', signal strength, Wi-Fi, time '08:44', and battery '76%'. The app header has the 'Xzense' logo and 'FAQ' button. Below the header, there is a title 'System control' with a right-pointing chevron. The main content area lists three control options, each with an icon and a status: 'Manual' (hand icon) is 'On', 'eXotelligence' (lightbulb icon) is 'Off', and 'Pressure controlled' (gears icon) is 'Off'. At the bottom, there is a navigation bar with four icons: a home icon, a gear icon, a camera icon, and a settings icon.</p>

## History

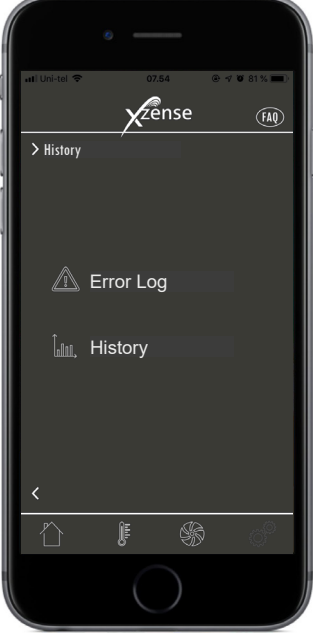
Step	Action	Display
1	Select the <i>Settings</i> option in the bottom menu. Select the <i>History</i> menu.	 A screenshot of an iPhone displaying the Xzense app's main menu. The screen is dark with white text and icons. At the top, the Xzense logo and a 'FAQ' button are visible. Below the logo are three menu items: 'Bluetooth' with a Bluetooth symbol, 'System control' with a gear-like icon, and 'History' with a notepad icon. At the bottom, there is a dock with four icons: a home button, a person icon, a camera icon, and a settings icon.
2	Choose either <i>Error Log</i> or <i>History</i> to get one overview of any. error messages, operating hours, etc.	 A screenshot of an iPhone displaying the Xzense app's 'History' screen. The screen is dark with white text and icons. At the top, the Xzense logo and a 'FAQ' button are visible. Below the logo, there is a back arrow and the text '> History'. Two menu items are listed: 'Error Log' with a warning triangle icon and 'History' with a bar chart icon. At the bottom, there is a dock with four icons: a home button, a person icon, a camera icon, and a settings icon.

**History**

In the history one can get an overview of the day in hours, the week, the month or the years that have passed.

3

You can create an overview of the following data:

- Temperature outside
- Chimney temperature
- Air pressure
- Chimney fan speed
- Operation hours
- Number of lightings

**Error Log**

4

In the Error Log, there is an overview of the error messages that may be have been on the way. The same overview can be found in the control panel.

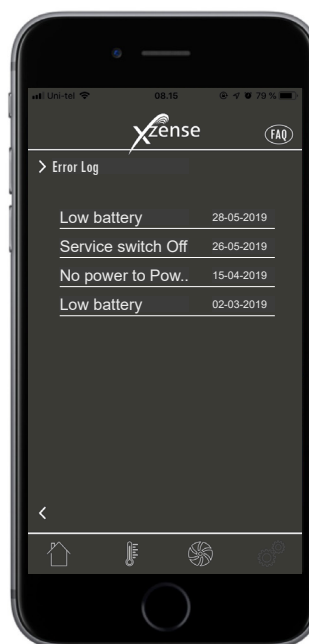

## 2.19. FAQ in the app

In the FAQ in the app you can find the frequently asked questions or small quick guides videos about using Xzense.

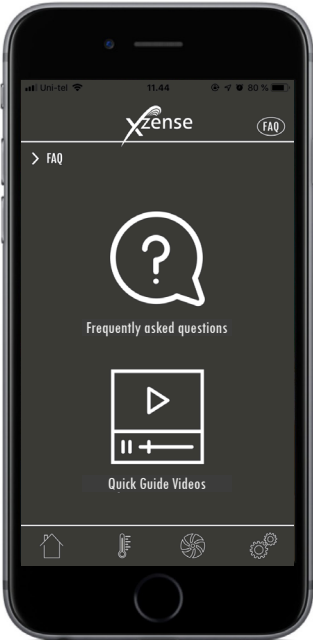
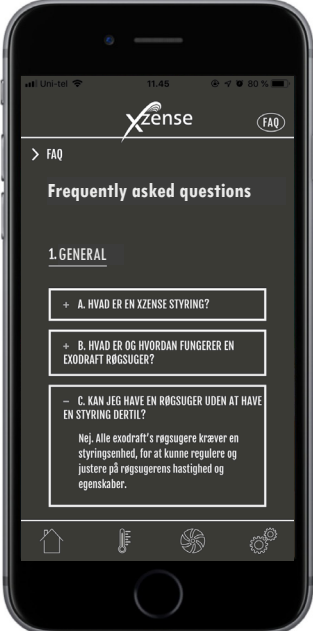
Step	Action	Display
1	Select the FAQ menu in the upper right corner	
2	<p><b>Frequently asked questions</b> Find the frequently asked questions in connection with Xzense. You can find some information on the following:</p> <ol style="list-style-type: none"> <li>1. General</li> <li>2. Installation</li> <li>3. Use and maintenance</li> <li>4. Technical specifications</li> </ol>	



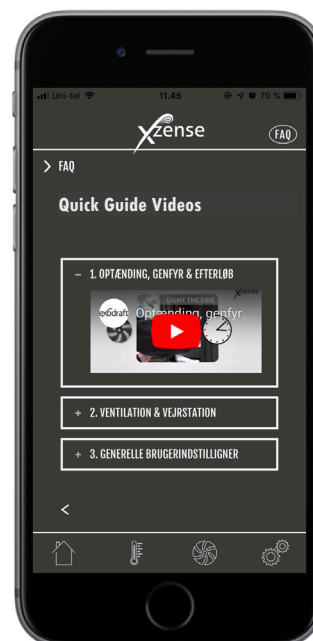

**Video Guides**

For a quick and easy review of:

1. Pairing with Power Unit
2. The use of Xzense (Lighting, Refring and Afterrun)
- 2 3. Xzense user settings (language, volume, brightness, etc.)
4. Pairing with Smartphone
5. Xzense App features
6. Signal test & software update
7. eXotelligence



## 2.20. Software update

Step	Action	Display
1	<p>When a new software version is released, an information box will appear on your phone in your app.</p> <p>Please note that you must have downloaded the Xzense app to your smartphone in order to update software on the control panel.</p> <p>Updating software can take up to 1 hour.</p> <p><b>Always make sure that there is power on your smartphone and the control panel when during the update!</b></p>	
2	<p>Select <b>YES</b> to update the software version.</p> <p>The app now downloads the software update.</p>	
3	<p>When the software update is downloaded 100% into the app, the control panel will start its software update.</p> <p>The software update is complete when the control panel reaches 100%.</p>	
*	<p>At the top left corner you can see which software version the app is in, below </p>	



### 3. Accessories - Repeater

***A repeater must be ordered/purchased separately and are not included in an Xzense set of Control panel and Power Unit!***

#### 3.1. Setup - Mounting

The repeater makes it possible to obtain a signal if there is too much distance between the control panel and the power unit or if the signal has to pass through, for example, several storeys.

The signal can at most go through 3 pcs. repeaters between an Xzense power unit and a control panel. The repeater is placed between the Xzense control panel and the power unit, which is typically mounted on the chimney. In some situations, it would be appropriate to set up the repeater outdoors, eg under the overhang or on another building. The signal may have difficulties to get through certain materials, for example, steel and aluminum constructions.

#### 3.2. Range

Range between units should not exceed 18 meters.

#### 3.3. Setting up one repeater

In the example to the right is shown a control panel (2) at the stove, a power unit (3) on the chimney and a repeater (1).

##### **Add the repeater to the control panel:**

1. Turn on the display and go to the Signal menu and select Devices.
2. Select the repeater in the overview to pair the devices. Enter the four digit code/ID of the specific repeater, finish with OK.
3. If the repeater does not appear by itself, Add device in the right corner can be used and the code/ID can be entered. Finish with OK.
4. Alternatively, the button on the repeater can be activated by holding it for 2 seconds. Then the pairing via the control panel can be done without code, if only the signal amplifier is selected on the overview within 2 minutes. When the devices are paired properly, a dialog box will appear.
5. Set up the repeater (1) somewhere between the power unit on the chimney and the control panel. The chimney fan can now be operated from the control panel.

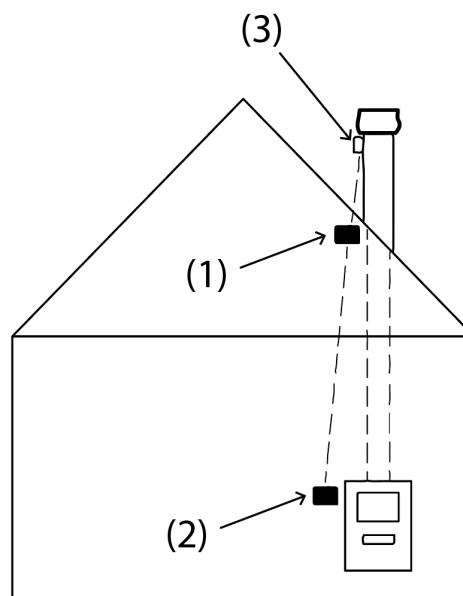

### Setting up multiple repeaters

In the example to the right is shown a control panel (2) at the stove, a power unit (3) on the chimney and 3 pcs. repeaters (1). The signal between the power unit and the control panel will go through all the repeaters here.

1. Location of first repeater (1). Use the control panel (2) to find the location that the signal can reach without a repeater.

2. Turn on the display and go to the Signal menu. Select Signal Test.  
The control panel now performs a signal test to ensure that there is an optimal signal between the control panel and the power unit.

3. Set up the repeater at the location where signal can still be obtained.

4. Activate the repeater by holding it for 2 seconds.

5. Turn on the display and go to the Signal menu and select Devices.

6. Select the repeater in the overview to pair the devices.  
Enter the four digit code/ID of the specific repeater, finish with OK.

7. If the repeater does not appear by itself, Add device in the right corner can be used and the code/ID can be entered.  
Finish with OK.

If no device can be found, it is because there is no signal and the repeater is too far away.

If more repeaters are required, follow the procedure in the above points.

The chimney fan can now be operated from the control panel.

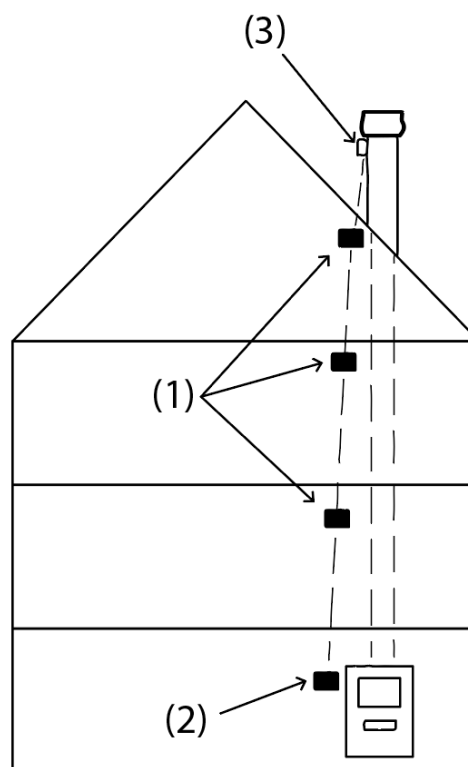

### 3.4. Technical data

<b>Dimension (h x b x d)</b>	75 mm x 85 mm x 25 mm
<b>Input, supply</b>	5 VDC - USB
<b>Ingress protection</b>	IP20
<b>Material</b>	Box: Black ABS - Lid: Black PC
<b>Ambient temperature</b>	-30 °C to 60 °C

## 4. Accessories - XTP sensor

***A XTP sensor must be ordered/purchased separately and are not included in an Xzense set of Control panel and Power Unit!***

### 4.1. Setup - Mounting

The installation must be carried out by competent persons.

The XTP sensor makes it possible to achieve a constant draft in the chimney, thereby ensuring optimum combustion during firing.

Xzense XTP sensor must always be mounted with the hose connectors downwards (fig. 1).

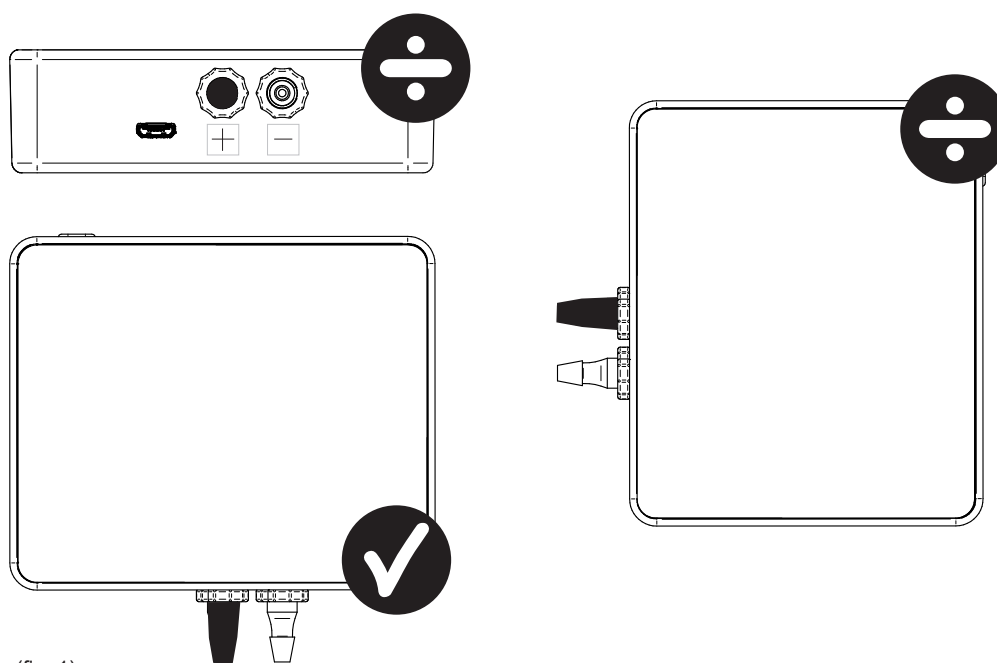

(fig. 1)

When underpressure measurement, the pressure hose is mounted on the (-) stud. Overpressure stud (+) must keep the black cap on.



**Do not blow in the stud of an Xzense XTP sensor!**



**Always have power/charging cable plugged in the XTP-sensor!**

### 4.2. Electrical connection



**All installations must be performed by competent persons in accordance with local laws and regulations.**

### 4.3. Add device/pairing devices

1. To add a device (XTP sensor) to the control panel, select the *Add device* menu on the display.



Add device

2. Already paired devices are displayed screen with a trash can. To pair with a new device, select a device with a link on it. Here, select the device XTP sensor.

XTP-sensor



3. A dialog box appears and confirms that the pairing has been done correctly. Always make sure you have both power control panel and XTP sensor during pairing.

Enhederne er nu parret.

OK

4. To run with the XTP sensor's system control, this must be selected below the *System management* menu, located under the *Setup* menu.



System management

5. Change system management from *Manual use* to *Pressure controlled* use by activating the ON function.



Pressure controlled

### 4.4. Technical data

<b>Responsibilities:</b>	5 Pa - 150 Pa +/- 0,1% Full scale
<b>Dimension (h x b x d):</b>	75 mm x 85 mm x 25 mm
<b>Weight:</b>	120 g
<b>Ingress protection:</b>	IP20
<b>Material:</b>	Box: Black ABS - Lid: Black PC
<b>Ambient temperature:</b>	-25 °C - +50 °C
<b>Storage temperature:</b>	-25 °C - +50 °C
<b>Input, supply:</b>	5 VDC - USB
<b>Permitted overpressure:</b>	20000 Pa
<b>Media:</b>	Air and flue gases

## 5. Technical specifications

### 5.1. Troubleshooting

#### Error message Overview

Types of errors	Description
Error 1 - "No connection to Power Unit"	Power Unit and control panel are too far apart.
Error 2 - "Temperature sensor missing"	The temperature sensor is not installed correctly or is malfunctioning.
Error 3 - "Temperature above 400°C!"	The temperature is too high in the chimney.
Error 4 - "No power to Power Unit!"	There is no power to the Power Unit.
Error 5 - "Not enough draft in the chimney"	There are not enough draft in the chimney to make it work optimally.
Error 6 - "Pressure sensor missing"	The pressure sensor is not installed correctly or has been lost connection to the device.
Error 7 - "Service Switch OFF"	The service switch is off (Power failure).
Error 8 - "Low Battery!"	The battery is low on power.

#### Corrective Actions

If none of the following works, you can always try to restart the panel.

See how to restart the panel in section "2.2. General use of the control panel" on page 8.

Observation*	Action
No light in the display on the control panel when activated	<ul style="list-style-type: none"> <li>• Charge the control panel</li> </ul>
Empty battery appears on the display	<ul style="list-style-type: none"> <li>• Charge the control panel</li> </ul>
Announcement; "Battery low" in a dialog box	<ul style="list-style-type: none"> <li>• Charge the control panel</li> </ul>
No draft in the chimney, but the display shows it is in operation	<ul style="list-style-type: none"> <li>• Check if the wing of the chimney fan is rotating</li> <li>• Check if the chimney is blocked</li> </ul>
The temperature does not appear in the display	<ul style="list-style-type: none"> <li>• Check the activation of the sensor in the menu</li> </ul>
The chimney fan does not start or stop automatically	<ul style="list-style-type: none"> <li>• Check the activation of the sensor in the menu</li> <li>• Check the start and stop temperatures under the Settings menu</li> <li>• Check that the sensor is positioned correctly below the fan</li> <li>• Replace if the sensor, if it is necessary and defective</li> </ul>
Announcement; "No signal" on the display	<ul style="list-style-type: none"> <li>• Check the control panel's distance from the Power Unit (max. 18 m).</li> <li>• Place the control panel in a more optimal location (for example, if conversion has been made, the signal may have deteriorated).</li> <li>• If a signal cannot be obtained, a repeater can be added to the network (see section 1.2 Accessories).</li> </ul>
Announcement; "Warning! To high chimney temperature" on the display	<ul style="list-style-type: none"> <li>• Excessive chimney temperature - limit the combustion.</li> <li>• Check the settings for the temperature in the Settings menu</li> </ul>
Announcement; "No units added" on display	<ul style="list-style-type: none"> <li>• No devices have been added to the control panel (see section 2.10 Signal test and add / delete units).</li> </ul>

\* Note: All alarm views will disappear when the error is corrected. See the overview of troubleshooting under the Error Log menu.

## 5.2. Technical data

Data	Control panel	Power Unit	Temperature sensor
<b>Dimensions mm H x B x D</b>	72 x 86 x 25	122 x 120 x 55	ø6 x 200
<b>Voltage</b>	5 V (USB)	230 V ± 10 % / 50 Hz	
<b>Protection</b>	IP20	IP54	
<b>Material</b>	ABS	PC	Stainless Steel
<b>Ambient</b>	0 °C til 40 °C	-30 °C til 60 °C	Sensor: -50 °C til 300 °C Cable: -50 °C til 125 °C
<b>Frequency for radiocommunications</b>	868 MHz	868 MHz / Bluetooth LE 2.4 GHz	
<b>Battery type</b>	Li-Po Battery		
<b>Battery life</b>	30 days (preliminary)*		
<b>Fuse</b>		T 2,0 A	
<b>Power output</b>		2 A	
<b>Standby consumption</b>		1 W	
<b>Type</b>			PT 1000

*\*The control panel has a service life of approx 30 days of normal use with deactivated bluetooth communication for a smartphone. It is recommended that the control panel charger plug is always used when Bluetooth is enabled, as battery life is significantly reduced by using the smartphone and the Bluetooth function.*

### 5.3. User and service menu

MENU	SUBMENU	TYPE	DESCRIPTION	FACTORY SETTING
<b>GENERAL</b>				
<b>Interface</b>				
	Language		Language selection shown in the menus: Danish, Swedish, Norwegian, German, English, French, Dutch, Polish and Finnish	English
	Contrast		Contrast from 0-100%	50%
	Brightness		Brightness from 0-100%	100%
	Sound		Sound from 0-100%	100%
<b>Setup</b>				
	Start temperature		Automatic start when temperature sensor measures: 5–100 °C	40 °C
	Stop temperature		Automatic stop when temperature sensor measures: 0–95 °C	35 °C
	Boost time		Time setting at startup (Boost): 1-15 min.	10 min.
	Stop time (Afterrun)		Time setting at stop (Afterrun): 1-200 min	30 min.
	Boost speed		Boost speed from 40-100%	100%
	Chimney draft		Chimney draft from 8-60 Pa	20 Pa
	Minimum fan speed		Minimum voltage level: 80 -120 V. Note: Min. 100 V if the chimney fan is an RS009.	100 V
	Eternal start			
	Fatory reset		Restores all factory settings: Yes/No	No
	Error log		Displays errors and alarms with date	
	Software version		Displays software version for enabled units: control panel, power unit, repeater and pres- sure sensor	
	System control		Control systems in the unit: Manuel/eXotelligence/ Pressure controlled	Manual
	Temperature sensor		Activation of temperature sensor: On/Off	On
	Alarm setpoint		High temperature alarm deviation setting: 150-400 °C	330 °C
	Boost stop setpoint		Stop temperature for boost	150 °C
<b>Network</b>				
	Signal			
		Devices	Add power unit, repeater and pressure sensor	
		Signal test	Displays the status of the signal	
		Reset network	Deletes all included devices: Yes/No Note: Also deletes the power unit from the network	No
	Bluetooth			
		Enable Bluetooth	Activating Bluetooth function: On/Off	Off

MENU	SUBMENU	TYPE	DESCRIPTION	FACTORY SETTING
<b>LIGHTING</b>				
<b>Lighting</b>				
		Boosting	Boost time during lighting	10 min. at 100%
		Operation	Setting the speed at the current operating situation	50%
		Reheating	Possibility of refring: Ja/Nej	35 °C
		Afterrun	Run time at the end of a burning cycle	30 min. at 50%
<b>VENTILATION</b>				
	Start	Start the fan	Start fans (Start/Turn off): 0-100%	50%
	Stop	Turn off the fan	Sluk ventilatoren (Sluk/Start)	
<b>WEATHER</b>	Outdoor	Outdoor temperature	The current temperature outside	Variable
	Chimney	Chimney temperature	The current temperature in the chimney	Variable
	Air pressure	The air pressure outside	The current air pressure outside	Variable





## 6. Declaration of Conformity

DK: EU-Overensstemmelseserklæring GB: Declaration of Conformity DE: EU-Konformitätserklärung FR: Déclaration de conformité de l'Union Européenne NO: EU-Samsvarserklæring PL: EU Deklaracja zgodności	NL: EU-Conformiteits verklaring SE: EU-Överensstämmelsedeklaration FI: EU-Vaatimustenmukaisuusvakuutus IS: ESS-Samræmisstaðfesting IT: Dichiarazione di Conformità Unione Europea
<b>exodraft a/s</b> <b>C.F. Tietgens Boulevard 41</b> <b>DK-5220 Odense SØ</b>	
Erklærer på eget ansvar, at følgende produkter: Hereby declares that the following products: Erklärt hierdurch auf eigene Verantwortung, daß folgende Produkte: Déclare, sous sa propre responsabilité, que les produits suivants: Erklærer på eget ansvar at følgende produkter: Niniejszym oświadczam, że następujące produkty:	Veklaart dat onderstaande producten: Deklarerar på eget ansvar, att följande produkter: Vastaa siltä, että seuraava tuote: Staðfesti à eigin ábyrgð, að eftirfarandi vörur: Dichiara con la presente che i seguenti prodotti:
<b>Xzense</b> <b>exodraft varenr. 522000X</b>	
Som er omfattet af denne erklæring, er i overensstemmelse med følgende standarder: Were manufactured in conformity with the provisions of the following standards: Die von dieser Erklärung umfaßt sind, den folgenden Normen: Auxquels s'applique cette déclaration sont en conformité avec les normes ci-contre: Som er omfattet av denne erklæring, er i samsvar med følgende standarder: Zostały wyprodukowane zgodnie z warunkami określonymi w następujących normach:	Zijn vervaardigd in overeenstemming met de voorschriften uit de hieronder genoemde normen en standaards: Som omfattas av denna deklaration, överensstämmer med följande standarder: Jota tämä selvitys koskee, on seuraavien standardien mukainen: Sem eru meðtalin í staðfestingu Pessari, eru í fullu samræmi við eftirtalda staðla: Sono stati fabbricati in conformità con le norme degli standard seguenti:
<b>EN60335-1, EN60335-2-80, DS/EN ISO 12100: 2011</b>	
I.h.t bestemmelser i direktiv: In accordance with Entsprechen gemäß den Bestimmungen der folgenden Richtlinien: Suivant les dispositions prévues aux directives: I.h.t bestemmelser i direktiv: Zgodnie z:	En voldoen aan de volgende richtlijnen: Enligt bestämmelserna i följande direktiv: Seuraavien direktiivien määräysten mukaan: Med tilvisun til ákvarðana eftirlits: In conformità con le direttive:
Maskindirektivet: The Machinery Directive: Richtlinie Maschinen: Directive Machines: Maskindirektivet: Dyrektywę maszynową:	De machinerichtlijn: Maskindirektivet Konedirektiivi: Vèlaeftirlitið: Direttiva Macchinari:
<b>2006/42/EF/-EEC/-EWG/-CEE</b>	
Lavspændingsdirektiv: The Low Voltage Directive: Niederspannungsrichtlinie: Directive Basse Tension: Lavspenningsdirektivet: Dyrektywę Niskonapięciową	De laagspanningsrichtlijn: Lågspänningsdirektivet: Pienjännitedirektiivi: Smáspennueftirlitið: Direttiva Basso Voltaggio:
<b>2014/35/EC</b>	
EMC-direktivet: And the EMC Directive: EMV-Richtlinie: Directive Compatibilité Electromagnétique: EMC-direktivet: Dyrektywę EMC – kompatybilności elektromagnetycznej	En de EMC richtlijn: EMC-direktivet: EMC-direktiivi: EMC-efirlitið: Direttiva Compatibilità Elettromagnetica:
<b>2014/30/EC</b>	
<b>Odense, 29.05.2019</b> Adm. direktør Managing Director <b>Jørgen Andersen</b> 	Algemeen directeur Geschäftsführender Direktor Président Directeur Général Verkställande direktör Toimitusjohtaja Framkvemdstjóri Direttore Generale







---

**DK: exodraft a/s**

C. F. Tietgens Boulevard 41  
DK-5220 Odense SØ  
Tel: +45 7010 2234  
Fax: +45 7010 2235  
info@exodraft.dk  
www.exodraft.dk

**SE: exodraft a/s**

Kasten Rönnowsgatan 3B 4tr  
SE-302 94 Halmstad  
Tlf: +46 (0)8-5000 1520  
info@exodraft.se  
www.exodraft.se

**NO: exodraft a/s**

Storgaten 88  
NO-3060 Svelvik  
Tel: +47 3329 7062  
info@exodraft.no  
www.exodraft.no

**UK: exodraft Ltd.**

10 Crestway, Tarleton  
GB-Preston PR4 6BE  
Tel: +44 (0)1494 465 166  
Fax: +44 (0)1494 465 163  
info@exodraft.co.uk  
www.exodraft.co.uk

**DE: exodraft GmbH**

Soonwaldstraße 6  
DE-55569 Monzingen  
Tel: +49 (0)6751 855 599-0  
Fax: +49 (0)6751 855 599-9  
info@exodraft.de  
www.exodraft.de