

# barbas .

## User manual

Gas Fire Panorama 90-55 PF2



Serial number:

Production date:

**© Barbas Bellfires BV**

This document or parts thereof may not be reproduced, stored in a retrieval system, or transmitted, in any form or by any means, electronic, mechanical, photocopying, recording, nor otherwise, without the prior written permission of Barbas Bellfires BV. This document could contain technical inaccuracies or typographical errors. Barbas Bellfires BV reserves the right to revise this document from time to time in the contents thereof.

**Contact information**

Barbas Bellfires BV

Hallenstraat 17, 5531 AB Bladel, The Netherlands

Phone: +31 49 733 9200

E-mail: [info@barbas.com](mailto:info@barbas.com)

## Contents

|          |   |           |
|----------|---|-----------|
| <b>1</b> | <b>About this document.....</b>                         | <b>5</b>  |
| 1.1      | How to work with this document.....                     | 5         |
| 1.2      | Warnings and cautions used in this document.....        | 5         |
| 1.3      | Related documentation.....                              | 5         |
| <b>2</b> | <b>Description.....</b>                                 | <b>6</b>  |
| 2.1      | Intended use.....                                       | 6         |
| 2.2      | Overview of the appliance.....                          | 6         |
| 2.3      | Overview of the remote control.....                     | 6         |
| 2.3.1    | Overview of the buttons.....                            | 7         |
| 2.3.2    | Overview of the display.....                            | 8         |
| 2.4      | Operation modes.....                                    | 8         |
| 2.4.1    | Thermostatic mode.....                                  | 8         |
| 2.4.2    | Program mode.....                                       | 8         |
| 2.4.3    | Eco mode.....   | 9         |
| 2.4.4    | Countdown timer mode.....                               | 9         |
| 2.5      | Overview of the control elements.....                   | 9         |
| 2.5.1    | Overview of the receiver.....                           | 9         |
| 2.5.2    | Overview of the fan/light module.....                   | 10        |
| <b>3</b> | <b>Safety.....</b>                                      | <b>11</b> |
| 3.1      | Safety devices on the appliance.....                    | 11        |
| 3.2      | Safety instructions for operation.....                  | 11        |
| 3.3      | Safety instructions with regard to the environment..... | 12        |
| <b>4</b> | <b>Operation.....</b>                                   | <b>13</b> |
| 4.1      | Preparation before first use.....                       | 13        |
| 4.1.1    | Do a check on the appliance.....                        | 13        |
| 4.1.2    | Prepare the appliance.....                              | 13        |
| 4.1.3    | Connect the receiver with the remote control.....       | 13        |
| 4.1.4    | Start the appliance.....                                | 13        |
| 4.2      | Set the remote control settings.....                    | 14        |
| 4.2.1    | Set the one/two-button operation.....                   | 14        |
| 4.2.2    | Set the temperature scale.....                          | 14        |
| 4.2.3    | Set the day and time.....                               | 14        |
| 4.3      | Operate the appliance.....                              | 15        |
| 4.3.1    | Operate the appliance with the remote control.....      | 15        |
| 4.4      | Change the settings.....                                | 20        |
| 4.4.1    | Set the temperature for the thermostatic mode.....      | 20        |
| 4.4.2    | Set the program mode settings.....                      | 20        |
| 4.4.3    | Set the countdown timer mode.....                       | 21        |
| <b>5</b> | <b>Maintenance.....</b>                                 | <b>22</b> |
| 5.1      | Maintenance schedule.....                               | 22        |
| 5.2      | Clean the appliance.....                                | 22        |
| 5.3      | Clean the standard glass.....                           | 22        |
| 5.4      | Clean the anti-reflective glass.....                    | 23        |

**6 Troubleshooting..... 24**

6.1 Troubleshooting table..... 24

6.2 Troubleshooting procedures..... 24

6.2.1 Replace the batteries of the remote control..... 24

**7 Technical data.....26**

7.1 Barbas Gas Fire Panorama 90-55 PF2 - GB, IE, ES, IT.....26

**8 Warranty Terms..... 28**

**9 EU-Declaration of Conformity..... 30**

# 1 About this document

This document shows the necessary information to do these tasks on the Gas Fire Panorama 90-55 PF2:

- Operate the appliance
- Do basic maintenance

This document refers to the Gas Fire Panorama 90-55 PF2 as 'the appliance'. This document is an essential part of your appliance. Read it carefully before you do work on the appliance. Keep it in a safe place.

The original instructions of the document are in English. All other language versions of the document are translations of the original instructions. It is not always possible to provide a detailed illustration of every single item of the equipment. The illustrations in this document show a typical setup. The illustrations are for instructional use only.

## 1.1 How to work with this document

1. Make yourself familiar with the structure and content of the document.
2. Read the safety chapter in detail.
3. Make sure that you understand all the instructions.
4. Do the procedures completely and in the given sequence.

## 1.2 Warnings and cautions used in this document

### Warning



If you do not obey these instructions, there is a risk that can cause personal injury or death.

### Caution

If you do not obey these instructions, there is a risk of damage to the equipment or to property.

### Note

A note shows more information.

| Symbol  | Description                        |
|---|------------------------------------|
|  | Visual sign that there is a hazard |
|  | Visual sign that there is a notice |

## 1.3 Related documentation

- Preparation manual
- Installation and maintenance manual
- User manual
- Assembly instructions for concentric flue system

## 2 Description

### 2.1 Intended use

Only use the appliance to heat the room in which the appliance is installed. Do not use the appliance for a different purpose.

### 2.2 Overview of the appliance

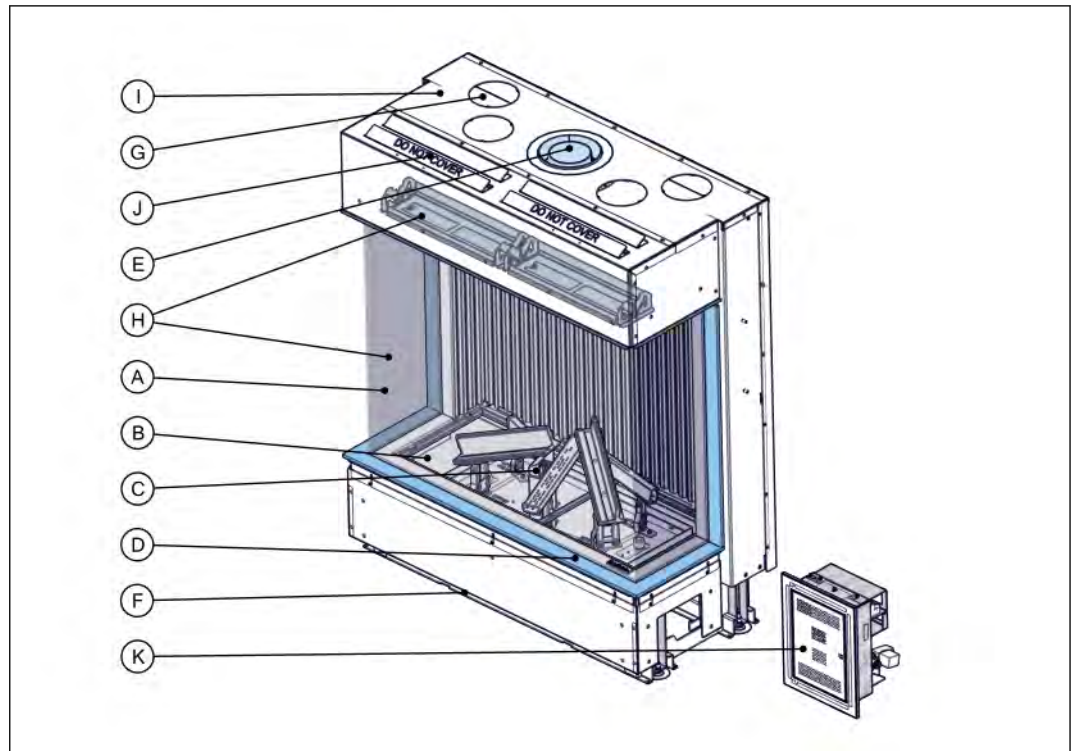

|   |                                 |   |                                  |
|---|---------------------------------|---|----------------------------------|
| A | Ceramic glass                   | G | Outlet convection air (optional) |
| B | Burner bed                      | H | Overpressure hatch               |
| C | Pilot light burner              | I | Convection casing (optional)     |
| D | Decorative frame                | J | Overpressure relief openings     |
| E | Concentric flue connection      | K | Operating unit                   |
| F | Inlet convection air (optional) |   |                                  |

Figure 1. Overview of Gas Fire Panorama 90-55 PF2

### 2.3 Overview of the remote control



**Note:** The remote control is not interchangeable with a remote control from a different model.

You can operate the appliance with the remote control. The remote control communicates with the receiver.

## 2.3.1 Overview of the buttons

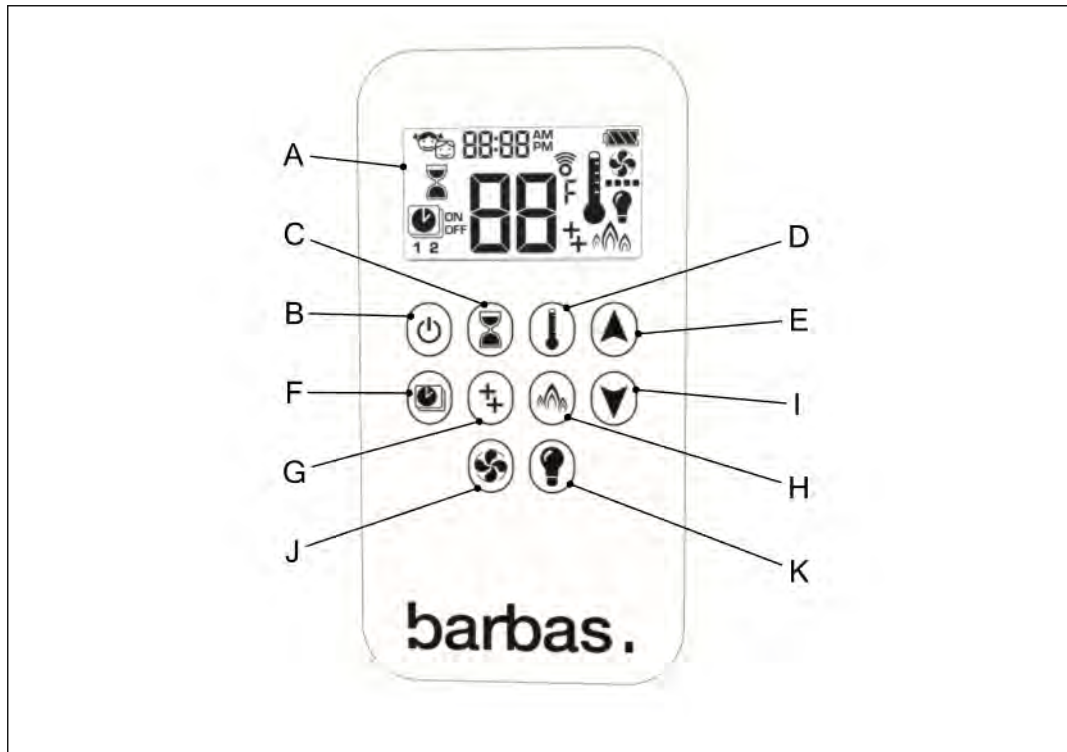

- |   |                   |   |                      |
|---|-------------------|---|----------------------|
| A | Display           | G | Burner mode          |
| B | On/off            | H | Eco mode             |
| C | Countdown timer   | I | Down                 |
| D | Thermostatic mode | J | Fan (Not applicable) |
| E | Up                | K | Light                |
| F | Program mode      |   |                      |

*Figure 2. Remote control buttons*

## 2.3.2 Overview of the display

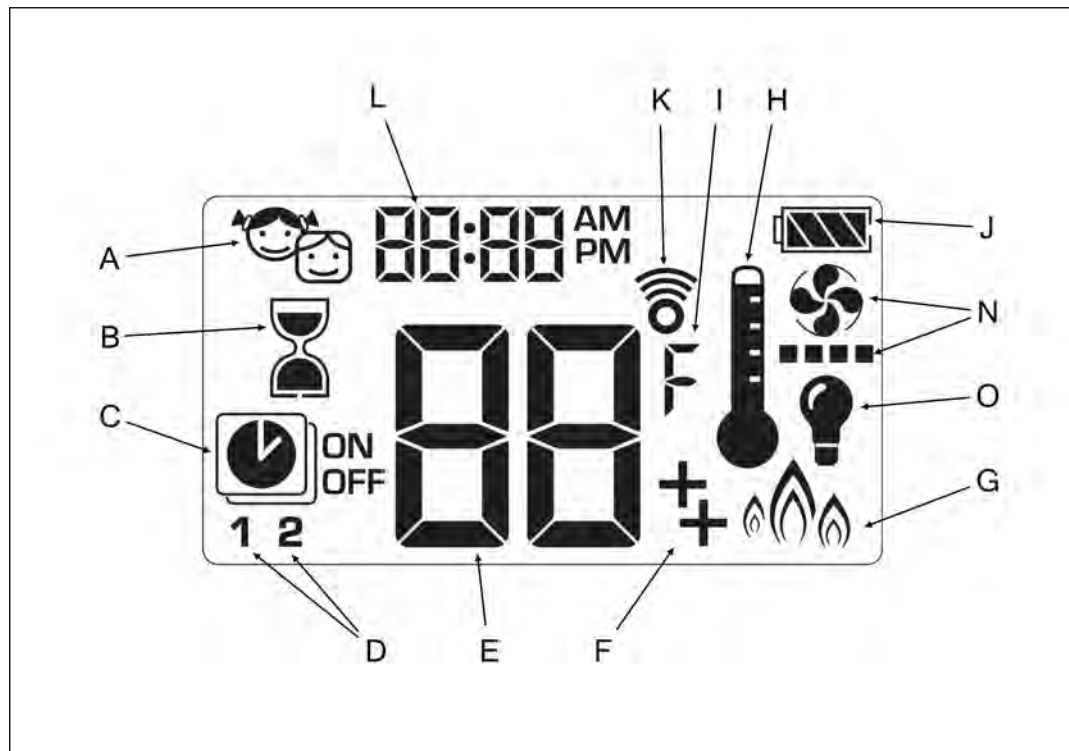

- |   |                        |   |                             |
|---|------------------------|---|-----------------------------|
| A | Child lock is on       | H | Thermostat is on            |
| B | Countdown timer is set | I | Temperature unit (°C or °F) |
| C | Program mode is set    | J | Battery status              |
| D | Active program number  | K | Signal transmission         |
| E | Temperature            | L | Current time                |
| F | Both burners on        | N | Not applicable              |
| G | ECO mode is set        | O | Light is on                 |

Figure 3. Remote control display

## 2.4 Operation modes

### 2.4.1 Thermostatic mode

In this mode the appliance measures the room temperature and compares this to the set temperature. The appliance automatically adjusts the flame height to make sure that the room temperature agrees with the set temperature.

### 2.4.2 Program mode

In this mode you can set two different programs. You can use these programs to start and stop the appliance at a set temperature on specific times and days.



## 2.4.3 Eco mode

In this mode the flame height changes between minimum and maximum height for the duration of a cycle:

- If the room temperature is lower than the set temperature, the flame height will stay high for a longer period of time.
- If the room temperature is higher than the set temperature, the flame height will stay low for a longer period of time.

A cycle in the eco mode continues for approximately 20 minutes.

## 2.4.4 Countdown timer mode

In this mode you can set a period of time after which the appliance stops. The countdown timer mode only operates when the appliance is set to the manual, thermostatic or eco mode.

## 2.5 Overview of the control elements

### 2.5.1 Overview of the receiver

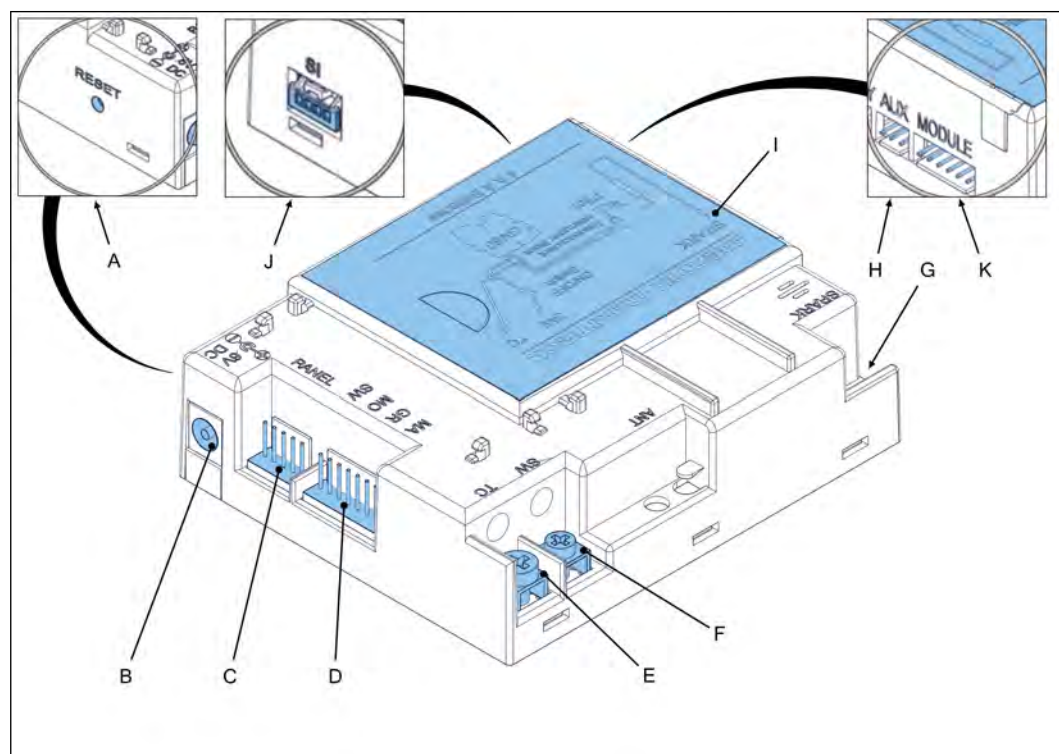

|   |  |   |   |
|---|--|---|---|
| A | Reset button   | G | Piezo cable connection                        |
| B | Connection for 6 VDC adapter                           | H | Connection to the gas valve rear burner (AUX) |
| C | Not used   | I | Battery compartment cover                     |
| D | 8 wire cable connection                                | J | Connection for an optional wifi-box (SI)      |
| E | Thermocouple voltage / current IN (red connection)     | K | Connection for the fan/light module (MODULE)  |
| F | Thermocouple voltage / current OUT (yellow connection) |   |   |

Figure 4. Receiver

## 2.5.2 Overview of the fan/light module

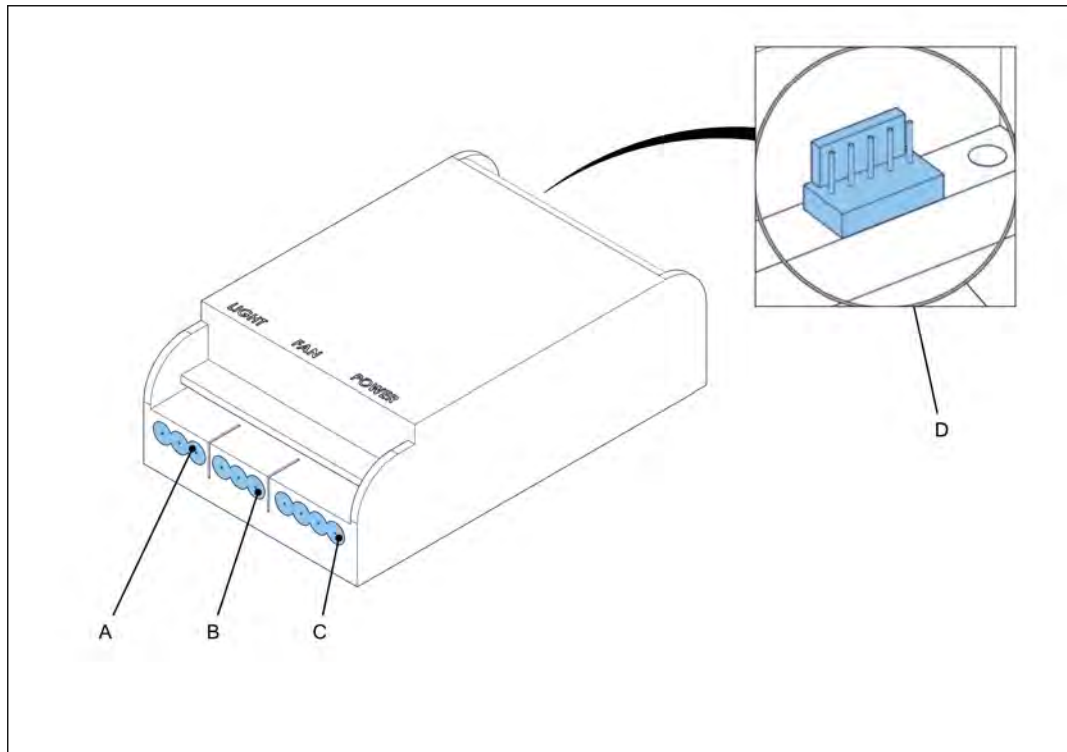

A Connection for the ambient lights  
B Connection for a convection fan

C connection for the power supply  
D Connection for the receiver

*Figure 5. Fan/light module*

## 3 Safety

### 3.1 Safety devices on the appliance

| Name   | Description   |
|--|---|
| Thermo-electric pilot light shut off                     | Prevents unforeseen discharge of gas from the main burner.  |
| Overpressure door (= glass front) and overpressure hatch | If an overpressure occurs in the appliance, the glass front door and the hatch opens for a short duration. When the door and hatch opens, a loud noise can occur. If an overpressure occurs, the installer must do a thorough check on the appliance. |

### 3.2 Safety instructions for operation



#### Warning:

- Do not put flammable items within 100 cm of the appliance.
- Do not use the appliance when the glass is removed.
- Do not use flammable fuels on the ceramic logs.
- Make sure that children are supervised when they can reach the appliance.
- Use a fire screen for heat protection.
- Make sure that there is sufficient ventilation in the room in which the appliance is installed.
- Do not use the appliance in case of visual glass damage.
- Make sure that the appliance is installed correctly. Refer to the Installation and Maintenance manual.
- Make sure that the appliance is installed and connected as a 'room sealed system' appliance by a certified and registered gas installation engineer.



#### Caution:

- Make sure that embers, vermiculite granules, ceramic logs or pebbles do not touch the pilot light burner.
- Make sure that the pilot light burner is not blocked.
- Do not adjust the position of embers, vermiculite granules, ceramic logs or pebbles on the main burner.
- Keep the remote control in a dry and cool place away from direct sunlight.
- Clean the glass when it is dirty. If the glass is not cleaned when it is dirty the glass can become permanently dull.
- Make sure that the yearly maintenance is done.
- Do not use the appliance for 4 weeks after installation. This time is necessary for the building materials to set.



#### Note:

- If you do not use the appliance for an extended period of time, close the gas supply.
- We recommend to set the appliance to stand-by mode (only the pilot light burns) during winter to prevent condensation in the appliance.

### **3.3 Safety instructions with regard to the environment**

- Dispose of the packing materials in an environmentally friendly way.
- Dispose of batteries as chemical waste.
- Dispose of ceramic heat-resistant glass as household waste. Do not dispose of ceramic heat-resistant glass in a glass recycling container.
- Dispose of an obsolete appliance according to instructions of the authorities or the fitter.
- Obey the local regulations.

## 4 Operation

### 4.1 Preparation before first use

#### 4.1.1 Do a check on the appliance

1. Make sure that the appliance is not damaged.
2. Make sure that the glass is not damaged.
3. Make sure that the pilot light operates correctly.

#### 4.1.2 Prepare the appliance



**Warning:**

- Do not use the appliance for 4 weeks after installation. This time is necessary for the building materials to set.
- Make sure that there is sufficient ventilation in the room in which the appliance is installed.



**Note:** The appliance has a heat-resistant coating. When you use the appliance for the first time, the coating can cause an unpleasant, but harmless smell.

1. Start the appliance, refer to section [4.3](#).
2. Set the flame height to maximum, refer to [4.3](#).
3. Keep the flame height to maximum for 10 minutes to make sure the chimney becomes warm.
4. Use the appliance with maximum flame height for several hours to remove the smell of the coating.
5. When the appliance is cool, clean the appliance. Refer to [5.2](#).

#### 4.1.3 Connect the receiver with the remote control



**Note:**

- You only have to connect the receiver once. Even when you change the batteries, the remote control stores the settings.

1. On the receiver, push and hold the reset button until you hear two beeps.
2. Within 20 seconds of the second beep, push and hold the down button on the remote control until you hear two short beeps. If you hear one long beep the receiver is not set, try again.
3. The remote control counts from 1 to 8, while making a connection with the receiver. The receiver is connected. If not, repeat the procedure.

#### 4.1.4 Start the appliance



**Warning:**

- Keep a minimum distance of 100 cm of the appliance when you start the pilot light.
- When the pilot light goes out, always wait 5 minutes before you start it again.

**Note:**

- The main burner burns at maximal height after start-up.
  - If the pilot light goes out and you start the appliance too early, the remote control will start but the fire will not burn. Restart the remote control.
- Start the appliance with the on/off button(s). Refer to [4.3](#).

## 4.2 Set the remote control settings

### 4.2.1 Set the one/two-button operation

- When the display shows '1', the one-button operation mode is selected.
  - When the display shows '2', the two-button operation mode is selected. This mode will prevent accidental start-up of the appliance.
1. Remove the batteries from the remote control.
  2. Put the batteries in the remote control. The screen starts to blink.
  3. Push and hold the on/off button for approximately 10 seconds. The current setting of the remote starts to blink.
  4. When the number changes and stops to blink, release the button.
    - The '1' changes into '2' when the remote control is set to the two-button operation.
    - The '2' changes into '1' when the remote control is set to the one-button operation.

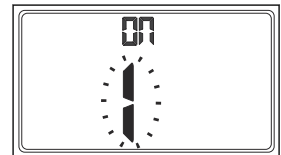
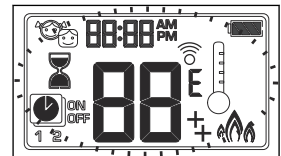

### 4.2.2 Set the temperature scale

- If you set the temperature scale to °C, the display shows a 24-hour clock.
- If you set the temperature scale to °F, the display shows a 12-hour clock.
- Push the on/off button and the countdown timer button at the same time to change the temperature scale between °C and °F.

### 4.2.3 Set the day and time

1. Push the up and down buttons at the same time. The day flashes in the display.
2. Use the up and down buttons select the day of the week (1 for Monday, 2 for Tuesday etc.).
3. Push the up and down buttons at the same time. The hour flashes in the display.
4. Use the up and down buttons to select the hour.
5. Push the up and down buttons at the same time. The minutes flash in the display.
6. Use the up and down buttons to select the minutes.
7. Push the up and down buttons at the same time to store the day and time settings.

## 4.3 Operate the appliance

### 4.3.1 Operate the appliance with the remote control

Table 1: Start and stop the appliance































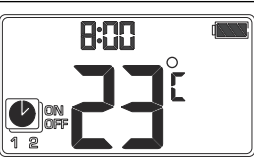

| Action  | Preconditions   | Steps  | Result   |
|---|---|--|--|
| Start the appliance with one-button operation | The remote control is set to the one-button operation. Refer to section <a href="#">4.2.1</a> . | Push   | <ul style="list-style-type: none"> <li>You hear a short beep.</li> </ul>                                      |
| Start the appliance with two-button operation | The remote control is set to the two-button operation. Refer to section <a href="#">4.2.1</a> . | Push  and  at the same time | <ul style="list-style-type: none"> <li>You can use the remote control when the main screen shows</li> </ul>  |
| Start the appliance from stand-by mode        | The appliance is set to stand-by mode.  | Push and hold   |   |
| Stop the appliance                            |   | Push   |   |

Table 2: Set the appliance to different modes

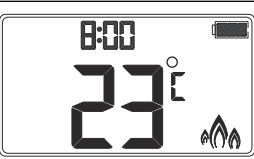
| Action                             | Preconditions | Steps  | Result  |
|------------------------------------|---------------|--|---|
| Set the appliance to stand-by mode |               | Push and hold  until only the pilot light burns   |    |
| Start the child proof mode         |               | Push  and  at the same time | You can only use the off function of the remote control.<br> |
| Stop the child proof mode          |               | Push  and  at the same time |    |
| Start the thermostatic mode        |               | Push   |   |
| Stop the thermostatic mode         |               | Push   |    |
| Start the program mode             |               | Push   |    |
| Stop the program mode              |               | Push   |    |
| Start the eco mode                 |               | Push   |    |
| Stop the eco mode                  |               | Push   |    |







| Action                         | Preconditions | Steps   | Result  |
|--------------------------------|---------------|---|---|
| Start the countdown timer mode |               | Push  |  |
| Stop the countdown timer mode  |               | Push  |  |

**Table 3: Start and stop the rear burner**











**Note:** When you start the appliance the front burner is on and the rear burner is set to the last setting. The rear burner is always set to the last selected setting, even when the batteries of the receiver are empty.

| Action                | Preconditions | Steps   | Result  |
|-----------------------|---------------|---|---|
| Start the rear burner |               | Push    |   |
| Stop the rear burner  |               | Push  |  |

**Table 4: Adjust the flame height**



**Note:** When you start the appliance the flame height is automatically set to maximum.

| Action                          | Preconditions                  | Steps   | Result  |
|---------------------------------|--------------------------------|---|---|
| Decrease the flame height       |                                | Push and hold  until you have the desired flame height |    |
| Increase the flame height       |                                | Push and hold  until you have the desired flame height |    |
| Set the flame height to maximum | The background lighting is on. | Tap  twice   |   |
| Set the flame height to minimum | The background lighting is on. | Tap  twice   |  |











**Table 5: Start and stop the light and adjust the brightness**



**Note:** The Light works independently of the Pilot flame.



**Note:** If the main burner and pilot light are switched off, with button , the light will switch off automatically.

| Action                        | Preconditions                        | Steps   | Result  |
|-------------------------------|--------------------------------------|---|---|
| Start the light               | Possible when the fire is on or off. | Push    |    |
| Stop the light                |                                      | Push    |   |
| Decrease the light brightness | The light symbol is on.              | <ul style="list-style-type: none"> <li>Push and hold  until the light symbol flashes</li> <li>Push and hold  until you have the desired light brightness</li> </ul> |  |
| Increase the light brightness | The light symbol is on.              | <ul style="list-style-type: none"> <li>Push and hold  until the light symbol flashes</li> <li>Push and hold  until you have the desired light brightness</li> </ul> |  |



**Note:**

Maximum thermostat 60 °C: The receiver in the appliance is fitted with a 60 °C maximum thermostat. When this thermostat is activated, the main burner will be completely switched off and the pilot light will continue to burn. The temperature in the receiver is measured every minute. The appliance cannot be operated again until the temperature has returned to below 60 °C.

**Note:**

To save energy, the pilot-flame automatically extinguishes when the appliance is not used for a period of 5 days. To avoid this, make two automatic start-stop actions per week in program mode. See chapter [4.4.2](#).

## 4.4 Change the settings

### 4.4.1 Set the temperature for the thermostatic mode

1. Push and hold the thermostatic mode button until the thermostatic mode symbol appears and the temperature flashes.
2. Use the up and down buttons to set the temperature.
3. Push the thermostatic mode button to store the temperature or wait until the temperature stops to flash.



### 4.4.2 Set the program mode settings

**Note:**

- The temperature for the starting time in the program mode is the same as the temperature that is set in the temperature mode.
- The set temperatures for the starting and stopping times of the appliance are the same for each day.
- When the batteries are removed from the remote control, the set temperatures, days and times are reset.

## Default settings:

- Temperature when the appliance starts: 21 °C (70 °F).
- Temperature when the appliance stops: "--" (pilot light only).

1. Push and hold the program mode button until the program mode flashes and 'ON' and the set temperature appears.
2. Tap the program mode button to continue. The display of the remote control shows 'OFF' and the temperature flashes.
3. Use the up and down buttons to set the temperature for the stopping time of the appliance.
4. Push the program mode button to store the temperature and to continue.
5. Use the up and down buttons to set the day(s) the program is active.

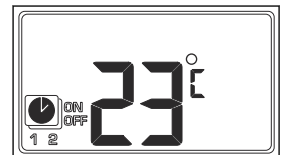
**Note:**

'ALL' (every day), 'SA:SU' (saturday and sunday), '1' (monday), '2' (tuesday), '3' (wednesday), '4' (thursday), '5' (friday), '6' (saturday) or '7' (sunday).

6. Push the program mode button to store the day.
7. Use the up and down buttons to select the hour on which the appliance starts up.
8. Push the program mode button to store the hour.

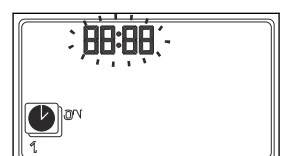
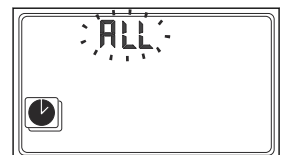

9. Select the minutes on which the appliance starts up and push the program mode button.
10. Select the hour and minutes for the stop time of the appliance.
11. If you do not want program 2 active in program mode, wait for the blinking to stop to save the settings.
12. If you want program 2 active, push the program mode button and set the on and off time for program 2.
13. Wait for the blinking to stop to save the settings.

### 4.4.3

#### Set the countdown timer mode



**Note:** The maximum period of time you can set for this mode is 9 hours and 50 minutes.

1. Push and hold the countdown timer button until the display shows the countdown timer symbol and the hour flashes.
2. Use the up and down buttons to select the number of hour.
3. Push the countdown timer button to store the hour. The minutes flash on the display.
4. Use the up and down buttons to select the number of minutes.
5. Push the countdown timer button to store the minutes.
6. Push the countdown timer button to confirm the countdown or wait.



## 5 Maintenance

### 5.1 Maintenance schedule



**Caution:**

Clean the glass when it is dirty. If the glass is not cleaned when it is dirty the glass can become permanently dull.

| Task                       | Frequency      | Procedure                            |
|----------------------------|----------------|--------------------------------------|
| Clean the appliance        | When necessary | Refer to section <a href="#">5.2</a> |
| Maintenance by your fitter | Yearly         | Refer to your fitter/dealer          |

### 5.2 Clean the appliance



**Warning:** Before the start of this procedure make sure the appliance is off and cooled down to room temperature.



**Note:**

- Use gloves to avoid visible fingerprints on the glass.
  - If you use a vacuum lifter to remove the glass, make sure that the suction pads are clean and dry. If the suction pads are not clean or dry, the suction pads can leave a mark.
1. Make sure that the appliance is off and is cooled down.
  2. Remove any dust from the operating unit. Use a vacuum cleaner.
  3. Do a check on the glass for damage. If you see damage, replace the glass. Do not use the appliance before the glass is replaced. For disposal of the glass, refer to chapter [3.3](#).
  4. Clean the glass, refer to chapter [5.3](#). For cleaning non-reflective glass refer to chapter [5.4](#).
    - a) If the inner side is dirty, remove the glass. Refer to the Installation and maintenance manual.
    - b) Install the glass. Refer to the Installation and maintenance manual.

### 5.3 Clean the standard glass



**Warning:** Before the start of this procedure make sure the appliance is off and cooled down to room temperature.



**Caution:**

If you have anti-reflective glass, refer to chapter [5.4](#), to avoid damage to the anti-reflective coating on the glass.

1. Clean the glass with a soft cloth, a sponge or paper. Use glass cleaner or ceramic hob cleaner.
2. Make sure that the glass is dry. Water droplets can leave a mark on the glass.

## 5.4 Clean the anti-reflective glass



**Warning:** Before the start of this procedure make sure the appliance is off and cooled down to room temperature.



**Caution:**

- Do not use hard (scouring) sponges, steel wool, abrasive products, caustic products, or cleaning agents that contain ammonia. The use of these items on the glass can damage the coating layers.
- Use neutral cleaning agents to clean the glass. This includes products like 'Instanet' or 'Glassex'.

1. Clean the glass with a soft cloth or a sponge.
2. Make sure that the glass is dry. Water droplets can leave a mark on the coating.

## 6 Troubleshooting

### 6.1 Troubleshooting table

| Problem  | Possible cause                                 | Possible solution  |
|--|--|--|
| The pilot light does not come on after three attempts.   |  | <ul style="list-style-type: none"> <li>• Close the gas supply</li> <li>• Contact your fitter.</li> </ul> |
| The burner does not operate within 10 seconds of firing the pilot light.                       |  |  |
| When the burner starts you hear a 'boom' sound.  |  |  |
| You hear a loud noise when the overpressure door (= glass front) and overpressure hatch opens. |  |  |
| You hear a continuous beep for five seconds.   | One of the cables is disconnected.             | Contact to your fitter.  |
| The appliance does not start.  | The gas supply is off.                         | Open the gas supply.   |
| The battery status of the remote control is empty  | The batteries of the remote control are empty. | Replace the batteries of the remote control. Refer to section <a href="#">6.2.1</a> .                    |
| The appliance does not respond to the remote control.  | The batteries of the remote control are empty. |  |
|  | The system has a failure.                      |  |
|  | There is no power supply (230 VAC).            | Repair the power supply.   |
|  |  |  |
| The appliance regularly stops for no reason.   |  | Contact your fitter.   |
| The glass is broken or cracked   |  | Replace the glass. For disposal of the glass refer to <a href="#">3.3</a> .                              |
| The lacquer of the appliance is damaged  |  | Contact your fitter.   |

### 6.2 Troubleshooting procedures

#### 6.2.1 Replace the batteries of the remote control



**Caution:**

- Only replace the batteries when the appliance is off.
- If you put the batteries in an incorrect position, this can cause damage to the electrical connections.
- Do not use rechargeable batteries.



**Note:**

We recommend the use of alkaline batteries.



1. Remove the cover of the remote control.
2. Remove all batteries.
3. Install new batteries. For approved batteries, refer to section [7](#).
4. Close the cover of the remote control.

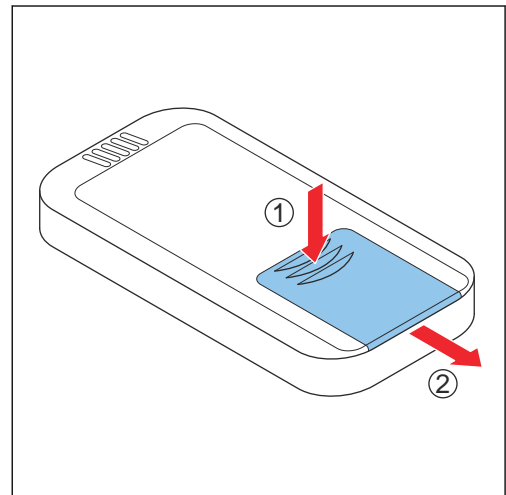

## 7 Technical data

### 7.1 Barbas Gas Fire Panorama 90-55 PF2 - GB, IE, ES, IT

**Table 6: Appliance classification**

|                                 | Natural gas G20                                     | Butane G30<br>Propane G31<br>Biopropane G31               |
|---------------------------------|---|---|
| Category of appliance           | I <sub>2H</sub> natural gas G20                     | I <sub>3+</sub> butane G30/propane G31/<br>biopropane G31 |
| Country                         | GB, IE, ES, IT                                      |   |
| Product identification no       | 0063 DL 3986  |   |
| Indirect heating functionality  | No  |   |
| Type of appliance under CE-norm | C <sub>11</sub> / C <sub>31</sub> / C <sub>91</sub> |   |
| Energy efficiency class         | A   |   |
| Energy efficiency index (EEI)   | 90  |   |

**Table 7: Technical performance / settings data**

|   | Natural gas G20                       | Butane G30                   | Propane G31<br>Biopropane G31 |
|---|---------------------------------------|------------------------------|-------------------------------|
| Nominal heat input<br>(Gross calorific value)                                     | 12.5 kW                               | 12.5 kW                      | 12.0 kW                       |
| Nominal heat output   | 9.6 kW                                | 9.6 kW                       | 9.2 kW                        |
| Minimum heat output (indicative)  | 6.0 kW                                | 5.4 kW                       | 5.3 kW                        |
| Useful efficiency (Net Calorific Value (NCV)) at nominal heat output              | 92.4 %                                | 93 %                         | 93 %                          |
| Useful efficiency (Net Calorific Value (NCV)) at minimum heat output (indicative) | 87 %                                  | 88 %                         | 88 %                          |
| NO <sub>x</sub> (max.) (Gross Calorific Value (GCV))                              | <130 mg/kWh <sub>input</sub>          | <130 mg/kWh <sub>input</sub> | <130 mg/kWh <sub>input</sub>  |
| NO <sub>x</sub> class   | 4                                     | 4                            | 4                             |
| Gas rate (max.)   | 1.19 m <sup>3</sup> <sub>s</sub> /hr. | 970 g/h                      | 860 g/h                       |
| Supply pressure   | 20.0 mbar                             | 29.0 mbar                    | 37.0 mbar                     |

**Table 8: Miscellaneous appliance data**

|   |  |
|---|--|
| Batteries remote control receiver   | None   |
| batteries remote control hand transmitter   | 2x 1.5V AAA  |
| Electrical connection   | 230 VAC / 50 Hz  |
| Auxiliary electricity consumption at nominal heat output  | 0.075 kW   |
| Auxiliary electricity consumption at minimum heat output  | 0 kW   |
| Auxiliary electricity consumption in standby mode   | 0 kW   |
| The specific precautions that shall be taken when the local space heater is assembled, installed or maintained, are listed in the attached documents: | <ul style="list-style-type: none"> <li>• Preparation manual</li> <li>• Installation and maintenance manual</li> <li>• User manual</li> <li>• Assembly instructions for concentric flue system</li> </ul> |

---

## 8 Warranty Terms

---

### **Barbas Bellfires Warranty Terms**

Barbas Bellfires B.V. guarantees the quality of the supplied Barbas appliance and the quality of the materials used. All Barbas appliances are developed and manufactured according to the highest possible quality standards. If, despite all this, something should prove amiss with the Barbas appliance you have purchased, Barbas Bellfires B.V. offers the following manufacturer's warranty.

#### **Article 1: Warranty**

1. If Barbas Bellfires B.V. determines that the Barbas appliance you have purchased is defective as a result of a flaw in the construction or material, Barbas Bellfires B.V. guarantees to repair or replace the appliance free of charge, without charging any costs for labor or spare parts.
2. Repair or replacement of the Barbas appliance will be undertaken by Barbas Bellfires B.V. or by a Barbas dealer as designated by Barbas Bellfires B.V.
3. This warranty is supplementary to the existing legal national warranty of Barbas dealers and Barbas Bellfires B.V. in the country of purchase and is not intended to restrict your rights and claims based on the applicable legal provisions.

#### **Article 2: Warranty conditions**

1. Should you wish to claim under the warranty, please contact your Barbas dealer.
2. Complaints should be reported as quickly as possible after they have manifested themselves.
3. Complaints will only be accepted if they are reported to the Barbas dealer, together with the serial number of the Barbas appliance which is stated on the front of the manual.
4. In addition, the original receipt (invoice, receipt, cash receipt) showing the date of purchase must also be submitted.
5. Repairs and replacements during the warranty period do not give any entitlement to an extension of the warranty period. After a repair or replacement of warranty parts, the warranty period shall be deemed to have started on the date of purchasing the Barbas appliance.
6. If a certain part is eligible for the warranty and the original part is no longer available, Barbas Bellfires B.V. shall ensure that an alternative part of at least the same quality shall be provided.

#### **Article 3: Warranty exclusions**

1. The warranty on the Barbas appliance ceases to be in effect if:
  - a. it is not installed according to the supplied installation instructions, and to national and/or local regulations;
  - b. it has been installed, connected or repaired by a non-Barbas dealer;
  - c. it has not be used or maintained according to the instructions for use;
  - d. it has been changed, neglected or roughly treated;
  - e. it has been damaged as a result of external causes (outside the appliance itself), for example, lightning strike, water damage or fire;
2. In addition, the warranty lapses if the original purchase receipt shows any change, deletion, removal or if it is illegible.

#### **Article 4: Warranty area**

1. The warranty is only valid in those countries where Barbas appliances are sold through an official dealer network.

#### **Article 5: Warranty period**

1. This warranty will only be granted during the warranty period.
2. The body of the Barbas appliance is guaranteed for a period of 10 years against construction and/or material faults, starting from the moment of purchase.
3. For other parts of the Barbas appliance, a similar warranty applies from the moment of purchase for a period of two years.
4. For user parts such as glass, glass (cord) and the interior of the combustion chamber, a similar guarantee is given until after the first burning.

#### **Article 6: Liability**

1. A claim granted by Barbas Bellfires B.V. under this warranty does not automatically imply that Barbas Bellfires B.V. also accepts liability for any possible damage. The liability of Barbas Bellfires B.V. never extends further than that stated in these warranty conditions. Any liability of Barbas Bellfires B.V. for consequential damage is expressly excluded.
2. That stated in this provision is not valid if and to the extent that it derives from a mandatory provision.
3. All agreements entered into by Barbas Bellfires B.V. are, unless specifically stated otherwise in writing and to the extent that they are permitted based on applicable law, subject to the FME-CWM general sales and delivery conditions for the technology industry.

Barbas Bellfires B.V.  
Hallenstraat 17 5531 AB Bladel  
The Netherlands  
Tel: +31-497339200  
Email: [info@Barbas.com](mailto:info@Barbas.com)

Carefully retain the user manual; it shows the serial number of the appliance. You will need this if you wish to claim under the warranty.

9 EU-Declaration of Conformity

**barbas bellfires .**

**EU-Declaration of Conformity**

We

**Manufacturer:** Barbas Bellfires  
**Address:** Hallenstraat 17  
 5531 AB Bladel, The Netherlands  
**Phone:** +31 497 339 200  
**email:** info@barbasbellfires.com

*declare that this declaration of conformity is issued under our sole responsibility and belongs to the product below:*

**Product:** Independent gas-fired convection heater  
**Type:** C<sub>11</sub>/C<sub>31</sub>/C<sub>51</sub>  
**Product name:** Barbas

**Description of the product:**

|                              |                              |                             |
|------------------------------|------------------------------|-----------------------------|
| Gas Fire Panorama 90-70 PF2  | Gas Fire Panorama 110-70 PF2 | Gas Fire Panorama 70-70 PF2 |
| Gas Fire Panorama 110-55 PF2 | Gas Fire Panorama 90-55 PF2  | Gas Fire Panorama 70-55 PF2 |

*The object of this declaration is in conformity with the relevant Union harmonisation legislation:*  
 Regulation (EU) 2016/426

*Used relevant harmonised standards or other technical specifications in relation to which conformity is declared:*  
 EN 613:2000

**The notified body:**  
 Kiwa Nederland BV  
 P.O. Box 137  
 NL-7300 AC Apeldoorn  
 performed a product verification and issued on January 13, 2021 certificate no: 20GR0534/00

**Signed for and on behalf of:**  
 Danny Baijens, managing director  
 (name and function)

Bladel, January 20, 2021





# barbas .

Your Barbas dealer