



SAUNA LUNA 2.3 X 2.4 M



PRODUCT DESCRIPTION

Meet the Luna, our new outdoor Sauna model that looks as good on the inside as it does on the outside. From its smooth curves to its large windows, it's built with a mix of comfort and modernity. The gently rounded corners have added appeal and give you lots of space for the Sauna. Door and windows with tempered tinted glass and eye-catching finishing details complete the high-quality impression, which continues confidently in the interior.

The benches and backrest in the Modern Outdoor Sauna Luna are made from deciduous wood and together create a uniquely relaxing atmosphere.

A strong accent is set by the warm white lighting, which underlines the pleasant warmth with exceptionally soft light, like a sunset by the sea.

Luna is either wood-fired or electric-heated and for the ultimate health experience, pair the sauna with sauna accessories such as the bucket and ladle, headrest, etc.

Modern Outdoor Sauna Luna features

Modern design Sauna seats up to 6 persons

Marine plywood frame construction

Walls and roof made from spruce wood

Walls and roof insulated in 10 cm rockwool (**as an extra**)

Premium quality door fittings

Adjustable ventilation

Two sauna room benches and backrests inside

Warm white LED downlighting in the sauna (under the benches and in the ceiling) (**as an extra**)

Delivery assembled or not assembled (KIT) with detailed assembly instructions

AVAILABLE OPTIONS:

All Sauna Room Interior From Deciduous Wood. The entire interior of the sauna room can be produced of deciduous wood (18 x 96 mm). As a standard, this type of wood is only used for sauna room benches and backrests.

Exterior Painting. Assembled and not assembled products can be painted. The high-quality preservative finish is professionally spray-applied in the factory to three sides of the wood. The product is treated in your choice of color.

Inside LED Lighting (For Assembled Products). In the sauna room ceilings, are on both sides under the sauna room backrests and benches.

Insulated Walls, Roof. Available to order with 100 mm rockwool insulation.

Windows. Available window modifications such as small windows (2 pcs of 180 x 880 mm) at the front and/or back wall, large window (1711 x 768 mm), or full glass wall in the back wall.



SPECIFICATION

People	4 - 6 persons
Timber	Spruce
Shape	Rectangle
Room	1
Inside area	4.0 m ²
Sauna area	4.0 m ²
Total height	2370 mm
Exterior Cladding	18 mm
Interior Cladding	12 mm
External dimension	2347 x 2240 mm
Door size	740 x 1725 mm
Window size	180 x 880 (2 pcs) mm

STANDARD SET

Marine plywood frame construction;

Walls and roof made from spruce wood;

Two windows at the front wall;

Door with a lock and a big tempered glass window;

Premium quality door fittings;

Adjustable ventilation;

Two sauna room benches and backrests inside;

Delivery assembled or not assembled (KIT) with detailed assembly instructions.

DELIVERY

Sauna LUNA is delivered to the customer assembled or not assembled, with detailed assembly instructions, drawings, maintenance and usage recommendations.

- **Size of pallet KIT (L x W x H):** 2.40 x 1.20 x 2.48 m;
- **Size of assembled product (L x W x H):** 2.44 x 2.35 x 2.40 m.

HEATER AND CHIMNEY KIT



Electric heater Harvia "Club",
13.5 kw + Harvia Xenio CX170
(11-20 m3)



Electric heater Harvia Globe
GL110E, 10.5kw + Harvia
Xenio CX170 (9-15m3)



Electric heater Harvia Leged
PO11, 11kW + Harvia Xenio
CX170 (9-20m3)



Electric Heater Harvia Leged
PO165, 16.5kW + Harvia Xenio
CX170 (16-35 m3)



Electric heater Harvia Trendi
KIP90, 9 kw (8 -14 m3)



Electric heater Harvia Vega
BC80, 8 kW (7-12 m3)



Harvia Cilindro PC90XE, 9kW +
Harvia Xenio CX001 (8-14m3)



Wood burning heater Harvia
M3 SL (outside feeding), 16.5
kw (6-13 m3)



Wood burning heater Harvia
M3, 16.5 kw (6-13 m3)



Wood burning heater Harvia
Pro 20, 24 kw (8-20 m3)



Wood burning heater Harvia
SL 20 (outside feeding), 24.1
kw (8-20 m3)

OPTIONS

INTERIOR FROM DECIDUOUS WOOD

Available to order sauna room all interior parts from deciduous wood (18 x 96 mm).

INSULATED WALLS AND ROOF

Available to order with 100 mm rockwool insulation.

LED LIGHTING (INSIDE)

INSIDE LIGHTING.

LED strips are used inside of the sauna room:

Under the sauna benches (on both sides)

Under the backrests (on both sides)

In the ceilings



ACCESSORIES



Bucket + Ladle Duo White



Clothes Hanger



Head Rest



Sauna Light



Sauna Light Cover



Heater Safety Fence for
Electric Heaters



Heater Safety Fence for
Woodburning Heaters



Water Tank For Woodburning
Heaters



Wooden Bucket



Wooden Ladle



Thermometer - Hydrometer

DRAWINGS

SAUNA LUNA 2.3 x 2.6 m DRAWINGS



Front view

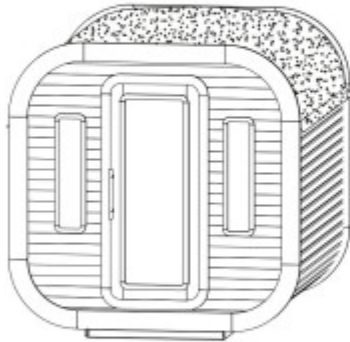

Cut view

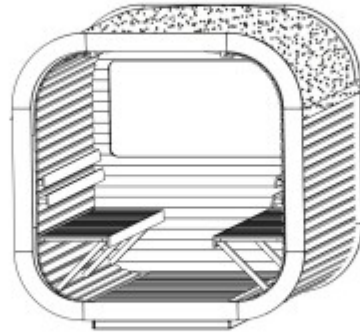

Top view



Front view

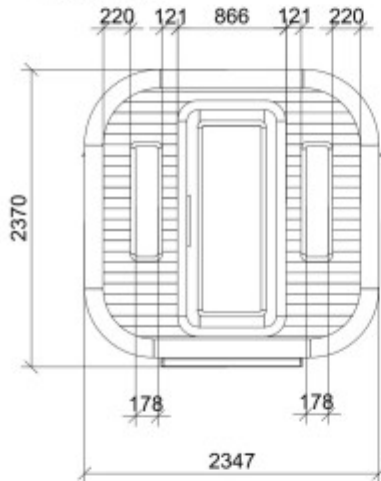

Back view

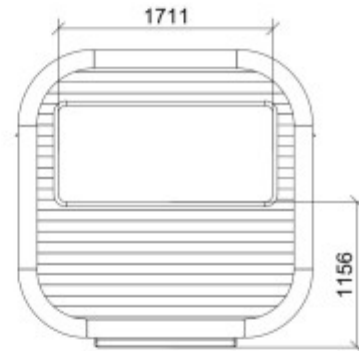

Side view



Plan

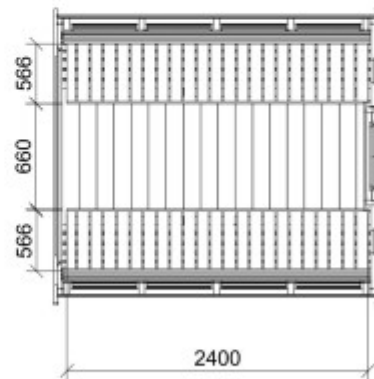

PAINTING

COLOR CARD

EXTERIOR WOOD STAIN COLORS



Water-based, quick drying premium total protection for wood outside.
Thin layer varnish – 3 in 1: impregnation, primer, and varnish!

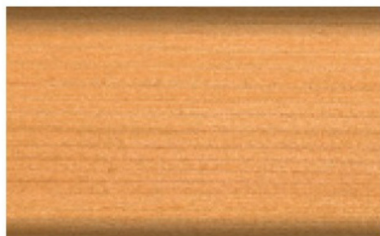

PINE / LARCH RC260

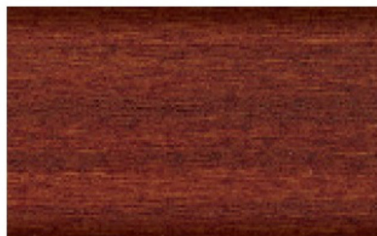

TEAK RC545

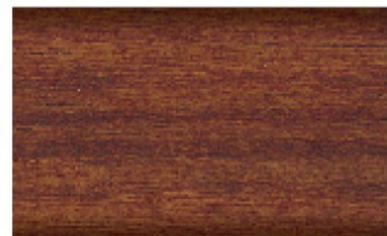

CHESTNUT RC555



FIR GREEN RC960

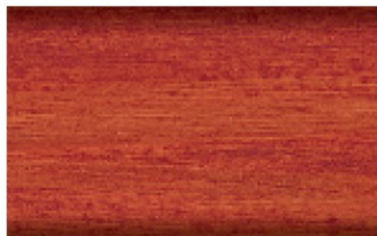

MAHAGONY RC565

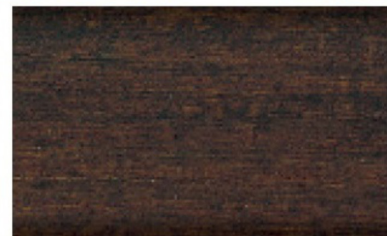

PALISANDER RC720



SILVER GREY RC970

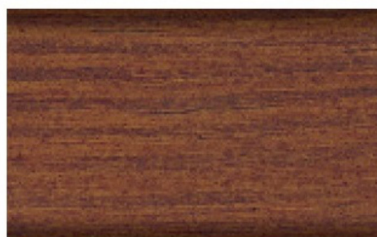

NUT WOOD RC660



PINE RC270

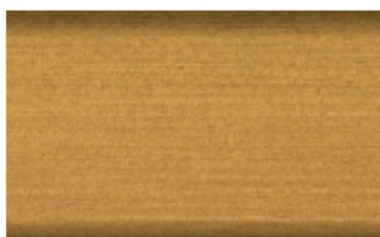

RUSTIC OAK RC360



LIGHT OAK RC365



HEMLOCK RC120



WHITE RC990

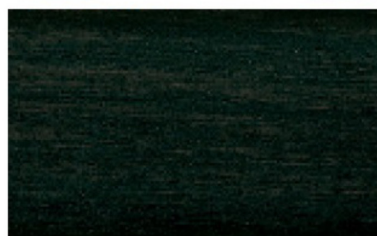

EBONY RC790

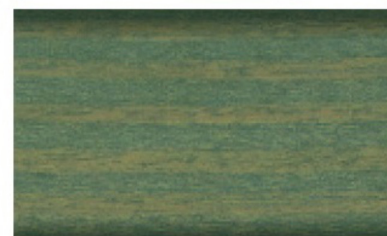

SALT GREEN RC965

PLEASE NOTE: The colors shown in the catalogue and website may not 100% match the color you will receive.
The color of the wood material affects the final color.

PAINTING

COLOR CARD

EXTERIOR WOOD PAINT COLORS

Weather protection, water-based paints. High-performance and environmentally friendly.

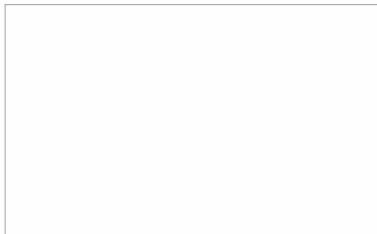

WHITE / RAL 9016



ANTRACITE GREY / RAL 7016

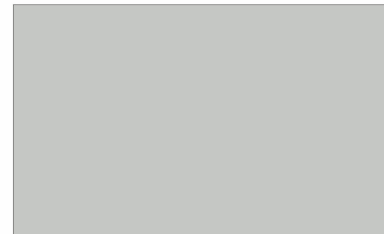

LIGHT GREY / RAL 7035



DUSTY GREY / RAL 7037

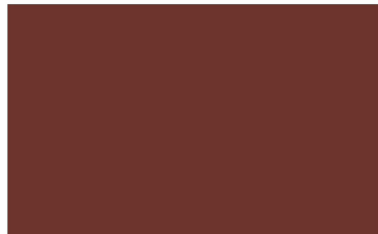

OXIDE RED / RAL 3009



JET BLACK / RAL 9005



MOSS GREEN / RAL 6005



AZURE BLUE / RAL 5009

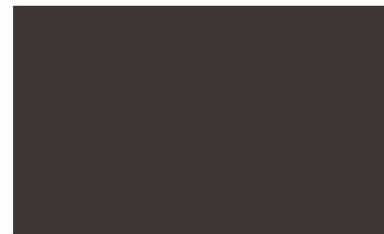

GREY BROWN / RAL 8019

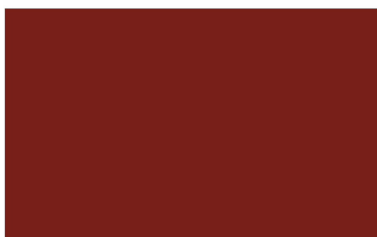

BROWN RED / RAL 3011

PLEASE NOTE: The colors shown in the catalogue and website may not 100% match the color you will receive. The color of the wood material affects the final color.

PAINTING

AUTOMATIC MACHINE SPRAY TECHNOLOGY

Benefits

One of the main and most obvious benefits of using a paint machine is the speed and flexibility at which we can suggest our painting service for all of our products. A spray paint machine can get the work done faster and more consistently than manually painting. While the machine works faster, it improves quality too – sprayers produce an even coat of paint, leaving a high-quality finish.

With our painting service from now, we can suggest our client's maximum flexibility! Not assembled products such as Grill cabins, Pavilions, Camping pods, and other products of any size you can order painted too!

PROFESSIONAL SPRAY

The high-quality preservative finish is professionally spray applied in the factory to three sides of the wood. The product is treated in your choice of color (one color for all product).

STAIN | PAINT

Which type of paint should I Use?

Properly painting and impregnating is one of the most important things to consider when thinking about how to extend your product's lifetime.

Paint and natural wood finish instantly spruce up the aesthetics of your product.

The decision you will need to make is if you want to use a water-based wood stain or paint. Both will offer you UV protection. The wood stains will allow the texture of the wood to show through and many are now available in a vast range of colors, however, paints will give you an intensive color, but will cover the grain and texture of the wood.

USAGE AND MAINTENANCE

USING YOUR SAUNA

PREPARING YOUR SAUNA FOR USE.

- If you have wood burning heater, make sure to remove the protective film of the heater chimney before heating.
- Check the Sauna before heating. No flammable objects must be left on or near the heater.
- Check that there is water in the water tank (if you are using it).
- Ensure that the Sauna door is unlocked and easy to open before using it. If necessary, sauna door must be adjusted by the customer.
- Do not mount any additional accessories or shelves above the heater.
- Turn the Sauna heater on.
- The thermometer should be located at head level in the Sauna. It should be further away from the heater, so it does not give a false reading.
- Wait for the Sauna to reach the required temperature (normally 80-90° C).

All users should be aware of the potential dangers and requirements prior to participation in the Sauna!

THINGS TO NOTE WHEN USING THE SAUNA

Enjoy the many health benefits of the relaxing heat of your Sauna. But remember: being inside the hot Sauna for long periods of time raises your body temperature, which may be dangerous, especially for those with a heart condition or other health risks. **Generally, the recommended time inside a Sauna is from 10 to 15 minutes.** After a period of heating, take a **5 minute break** and then repeat. Also:

- Familiarize yourself with the safety instructions and keep away from the heater when it is hot.
- Be very careful when moving in the Sauna, as the benches and floors may be slippery!
- The Sauna should not be used by pregnant women or very young children.
- Remove all jewelry before entering the hot Sauna.

MAINTENANCE

Wood is a natural material and can change through time. Cracks of various sizes, structural or color changes are not the defects – rather, they are features of the wood. Natural wood (not impregnated) becomes grayish after being left untouched for a while. Later it can turn blue and get covered with mold.

- Impregnate and paint the wood to protect the product from outside. We recommend to inspect Sauna every 6 month and evaluate need of re-impregnation, re-painting.
- When not in use, keep a bucket full of water in the Sauna during summer.
- Doors of the Sauna must be adjusted regularly.
- You should keep the sauna ventilation open all the time, to allow it time to dry and air out to avoid mold.
- To remove bench stains, use a mild soapy water and a soft cotton cloth. This can also be used on the heater itself - just make sure it's off and completely cool when you clean it.
- Don't use harsh or abrasive chemicals on benches, as these can bleach and warp the wood, ruining the grain and turning it grey.

With these simple maintenance tips your Sauna will stay inviting, fresh, and enjoyable!



Misko 25, LT-85302 Venta, Lithuania
info@vikingindustrier.com

www.vikingindustrier.com